

**INSTRUCTION MANUAL  
MODEL 441AL  
FREQUENCY-TO-VOLTAGE  
CONVERTER**

The information contained in this manual is proprietary. Permission to reproduce all or part must first be obtained in writing from this company.

Ectron Corporation reserves the right to make specification changes at any time.

**LIFE-SUPPORT POLICY:** Ectron products are not authorized for use in life-support devices or systems without the express, written approval of the president of Ectron Corporation.

Copyright 2003  
Ectron Corporation  
All rights reserved

Revised September, 2015

Ectron Corporation  
8159 Engineer Road  
San Diego, CA 92111-1907  
U.S.A.

858-278-0600  
800-732-8159

*Fax: 858-278-0372*

www.ectron.com  
sales@ectron.com

# Warranty

## GENERAL

All Ectron instruments are warranted against defects in material and workmanship for one year from the date of shipment to the original purchaser. Ectron agrees to repair or replace any assembly or components (except expendable items such as fuses, lamps, batteries, etc.) found to be defective during this period. Ectron's obligation under this warranty is limited solely to repairing or replacing, at its option, an instrument that in Ectron's sole opinion proves to be defective within the scope of the warranty when returned to the factory or to an authorized service center. Transportation to the factory or service center is to be prepaid by the purchaser. Shipment should not be made without the prior authorization of Ectron. This warranty does not apply to products repaired or altered by persons not authorized by Ectron, or not in accordance with instructions furnished by Ectron. If the instrument is defective as a result of misuse, improper repair, alteration, neglect, or abnormal conditions of operation repairs will be billed at Ectron's normal rates. Ectron assumes no liability for secondary charges of consequential damages as a result of an alleged breach of this warranty; and in any event, Ectron's liability for breach of warranty under any contract or otherwise shall not exceed the purchase price of the specific instrument shipped and against which a claim is made. This warranty is in lieu of all other warranties, expressed or implied; and no representative or person is authorized to represent or assume for Ectron any liability in connections with the sale of our products other than is set forth herein.

## PROCEDURE FOR SERVICE

If a fault develops, notify Ectron or its local representative, giving full details of the difficulty. Include the model and serial numbers. On receipt of this information, a service date or shipping instructions will be furnished. If shipment is indicated, forward the instrument, freight prepaid, to the factory or to the authorized service center indicated in the instructions.

## DAMAGE IN TRANSIT

Instruments should be tested upon receipt. If there is any damage, a claim should be filed with the carrier. A full report of the damage should be obtained by the claim agent, and that report should be forwarded to Ectron. Ectron will advise the disposition to be made of the equipment and arrange for repair or replacement. Please include model and serial numbers in all correspondence.



---

# Table of Contents

---

	<b>PAGE</b>
<b>Warranty</b>	<b>Inside Front Cover</b>
<b>Section I, Description</b>	
General	1-1
Features	1-1
About this Manual	1-3
Abbreviations	1-4
<b>Section II, Specifications</b>	
General	2-1
Input	2-1
Output	2-1
Frequency-to-voltage Conversion	2-3
Calibration	2-3
Alignment	2-4
Front Panel	2-4
Retention of Settings	2-4
Input Power	2-4
Environment	2-4
Dimensions	2-5
Compatibility	2-5
<b>Section III, Operation</b>	
General	3-1
Connections	3-1
Operational-state Diagram	3-1
Limits vs Settings	3-4
View Angle	3-4
Controlling the Model 441AL	3-4
Operate Screen	3-6
Frequency-set Screen	3-6
Voltage-set Screen	3-7
Input-signal Screens	3-7
Pulses/Revolution Screen	3-7
Input-sensitivity Screen	3-8
Input-B/W (Filter) Screen	3-9
Output-filter Screen	3-9

---

	<b>PAGE</b>
Cal Screen	3-10
Secondary Screens	3-10
Ten-volt Alignment	3-11
Reset	3-12
Enclosures	3-13
Model E408-1	3-13
Model E408-6	3-13
Model R408-14	3-14
<b>Section IV, Applications</b>	
General	4-1
Input-signal Conditioner	4-1
Input Signal, Grounding, and Shielding	4-1
Emi Protection	4-2
Frequency-to-analog Conversion	4-2
Output Analog Filter and Output Stage	4-2
Frequency and Voltage Set Points	4-2
Noise	4-3
Uncertainty and Resolution	4-4
Filtering	4-6
Input Bandwidth Filter	4-7
Output Filter	4-7
Digital Filter	4-9
Response Time	4-11
Update Rate	4-11
Latency	4-11
Front-panel Indication	4-11
Calibration	4-11
<b>Section V, Theory of Operation</b>	
General	5-1
Signal Conditioning (Hardware)	5-2
Frequency Measurement (Firmware)	5-2
Transfer Function (Firmware)	5-2
Output Stages (Hardware)	5-2
Power Supplies (Hardware)	5-2
<b>Section VI, Alignment and Calibration</b>	
Equipment Required	6-1
Pre-calibration	6-2

---

	<b>PAGE</b>
Alignment	6-4
Post-calibration	6-5
Optional Calibration Tests	6-5
Ectron Model 441AL Calibration Test Report	6-7
<b>Section VII, Parts Lists</b>	
Names of Manufacturers	7-1
Model E408-6 Enclosure	7-2
Model R408-14 Enclosure	7-3
<b>Figures</b>	
Model 441AL	1-1
Figure 3-1, Operational-state Diagram	3-2
Figure 3-2, View-angle Screens	3-4
Figure 3-3, Operate Screen	3-6
Figure 3-4, Frequency-set Screen	3-6
Figure 3-5, Voltage-set Screen	3-7
Figure 3-6, Pulses/Revolution Screen	3-8
Figure 3-7, Input-sensitivity Screen	3-8
Figure 3-8, Input-bandwidth Screen	3-9
Figure 3-9, Output-filter Screen	3-9
Figure 3-10, CAL Screen	3-10
Figure 3-11, Adjust 10 V Screen	3-11
Figure 3-12, Alignment-required Screen	3-11
Figure 3-13, Memory-error Screen	3-12
Figure 3-14, Reset Screen	3-12
Figure 4-1, Maximum Uncertainty for Various Frequencies	4-4
Figure 4-2, Worst-case Resolution for Various Frequencies	4-5
Figure 4-3, Maximum of Uncertainty and Resolution for Various Frequencies	4-6
Figure 4-4, Maximum Output Noise with a 10 mV Sine-wave Input	4-7
Figure 4-5, Maximum Output Noise with a 1 V Sine-wave Input	4-8
Figure 4-6, Effects of the Digital (Periodic-error) Filter	4-10
Figure 5-1, Model 441AL Block Diagram	5-1
Figure 6-1, Frequency-range Setup	6-2
Figure 6-2, Frequency-calibration Setup	6-3

---

	<b>PAGE</b>
Figure 6-3, Alignment	6-4
Figure 6-4, Optional Tests	6-5
<b>Tables</b>	
Table 1-1, Abbreviations in This Manual	1-4
Table 2-1, Input Bandwidth and Sensitivity Settings	2-1
Table 2-2, Front-panel Screens	2-6
Table 3-1, Connector-pin Assignments	3-1
Table 3-2, Default Settings and Limits	3-3
Table 4-1, Input Frequency vs Output Voltage (Example)	4-3
Table 4-2, Response Time Versus Output Filter Setting	4-8
Table 6-1, Input Sensitivity	6-6
Table 7-1, List of Manufacturers	7-1
<b>Schematics and Drawings</b>	
Model E408-6Y (Internal 12 V dc Power Supply)	408-600
Model E408-6X (Internal 28 V dc Power Supply)	408-601
Model R408-14Y (Internal 12 V dc Power Supply)	408-605
Model R408-14X (Internal 28 V dc Power Supply)	408-606
Model 441A/441AL Outline Dimensions	441-901
Model E408-1 Outline Dimensions	408-900

---

## Section I

# Description

---

### GENERAL

The Model 441AL produces an analog voltage that precisely represents the frequency of an applied input signal. Adjustable “input frequency to output voltage” set points allow the user to quickly bracket the frequency of interest.

A unique crystal-controlled micro-controller design provides fast response, high conversion accuracy, and low output noise that is independent of frequency. In the operate mode, the front-panel display shows the input frequency with up to five-digit resolution. All operating parameters are set using the display and only one other front-panel control. It's that easy. Designed to accept signals from active conditioners, the Model 441AL provides stable operation for three ranges of pulse input: 0 V to 5 V, 0 V to 25 V, and 0 V to 100 V.



**Model 441AL**  
**Frequency-to-voltage Converter**

### FEATURES

**Reliable “state of  
the art” design**

The Model 441AL combines the same rugged construction used in the Ectron 400 Series product line for the last 30 years with the latest electronic and surface-mount technology to produce a true breakthrough in frequency-to-voltage conversion.

Designed in are rapid response to any change in frequency, low output noise that is independent of input frequency, and input-signal conditioning that accommodates input signals over a wide range of input voltages.

---

<b>Simplicity</b>	Gone is the clutter of switches, knobs, pots, etc. associated with other frequency-to-voltage converters. All has been replaced with two easy-to-use controls that allow complete control: the display and the encoder.
<b>Display</b>	The backlit digital display has the dual function of display and screen selection. Nine easy-to-use setup screens, four less frequently used screens, as well as the operate screen are accessible to the user at the touch of the display.
<b>Encoder</b>	With just this one additional control, the user can completely and easily configure the Model 441AL to precisely what the situation requires. The encoder also has a dual purpose: character selection and change.
<b>Wide range of applications</b>	With an input-frequency range of 1 Hz to 50 kHz and an output-voltage range of $-10\text{ V}$ to $+10\text{ V}$ , the user can employ the Model 441AL to study a wide variety of frequency-producing equipment. This is in keeping with Ectron's intent to provide instruments with wide application for the serious user.
<b>Power</b>	The Model 441AL operates from any dc power from $10.5\text{ V}$ to $32\text{ V}$ . This simplifies test-configuration setup for the user and may even reduce the cost if fewer power sources are required.
<b>Model 441AL versus Model 441A</b>	<p>The Model 441AL incorporates a fixed-gain logic-level input detector instead of the input automatic gain control (AGC) of the Model 441A. The Model 441AL is designed to operate with fixed-level input signals with relatively sharp rise and fall times. The input can be set to accommodate levels of <math>0\text{ V}</math> to <math>5\text{ V}</math>, <math>0\text{ V}</math> to <math>25\text{ V}</math>, and <math>0\text{ V}</math> to <math>100\text{ V}</math>.</p> <p>The fixed gain of the Model 441AL input stage reduces the delay in responding to an abruptly starting input signal unlike the AGC circuit, which has a hard time responding quickly to an input signal that starts suddenly. AGC timing is a compromise between fast response and noise immunity. As a result the AGC may not keep up with a rapidly rising input amplitude: the Model 441A may not respond to this signal for several hundred milliseconds. A similar situation exists for a rapidly falling input amplitude. These delays are reduced to one millisecond plus one period of the input signal in the Model 441AL since no AGC stage is present.</p>
<b>Enclosures</b>	Because the Model 441AL uses the same connector as all other 400 Series products, it can be used in all Ectron enclosures designed for this product line — even intermixed with Model 428 and 352 conditioner-amplifiers and Model 451 LVDT signal conditioner. The Model



---

441AL uses the same input and output pins as do these other products, so the user who has existing hardware in place can remove an amplifier-conditioner and plug in the frequency-to-voltage converter and start using it immediately.

## **ABOUT THIS MANUAL**

The following sections are in this manual:

### **Specifications**

This is a complete technical description of the Model 441AL and the performance that is guaranteed. While the performance specifications are the best in frequency-to-voltage conversion, they are conservative. The user may find that a particular unit will perform well beyond specification.

### **Operation**

Here the user will find complete instructions to use the Model 441AL. Pictures of all the screens and an operational-state diagram enhance the discussion. Also discussed are the various enclosures available for the Model 441AL and other 352 and 400 Series units.

### **Applications**

Because the Model 441AL is designed as a universal frequency-to-voltage converter, it would be impossible to address every possible use for this product. Rather, this section is written to help the user get the most from the data resulting from using the Model 441AL. Concerns about cabling, shielding, common-mode voltage, etc. are addressed.

### **Theory of operation**

Because the Model 441AL is an encapsulated unit, repair in the field is strongly discouraged. Therefore, a detailed circuit analysis is foregone in this manual. However, theory at the block-diagram level as well as a discussion of internal software is presented to further aid the user in operating the frequency-to-voltage converter for best performance.

### **Calibration**

Step-by-step instructions are given to test the Model 441AL against its specifications. A brief overview of each test is given to give the technician further insight into each test performed.

### **Drawings**

Schematic diagrams of several enclosures are included to aid the user in instrumentation configuration.

### **Warranty**

The warranty for this product is on the inside of the front cover.

## ABBREVIATIONS

Table 1-1 lists the abbreviations used throughout the manual.

**Table 1-1**  
**Abbreviations in This Manual**

Symbol	Meaning	Typical use
ac	Alternating current	120 V ac
A	Ampere	Power current = 150 mA
C	Centigrade	50°C
dc	Direct current	10.5 V dc to 32 V dc
°	Degree	50°C
$f_{co}$	Filter cutoff frequency	$f_{co} = 100$ Hz
$f_{in}$	Input frequency	$f_{in}$ can be 1 Hz to 50 kHz
F	Farad	Input Impedance = ... 300 pF...
$f_U$	Upper-frequency set point	Volts-per-hertz resolution = $\frac{V_U - V_L}{f_U - f_L}$
$f_L$	Lower-frequency set point	See $f_U$
g	Gravitational force, gram	Shock resistance = 20 g Weight = 270 g
Hz	Hertz (cycles per second)	$f_{in}$ can be 1 Hz to 50 kHz
k	Kilo ( $1 \times 10^3$ )	Maximum frequency = 50 kHz
M	Mega ( $1 \times 10^6$ )	Noise-measurement bandwidth = ...1 MHz
m	Milli ( $1 \times 10^{-3}$ ), meter	Width = 28.4 mm
$\Omega$	Ohm	Output impedance = 1 $\Omega$ ...
oz	Ounce	Weight = 9 oz, nominal
p	Peak, pico ( $1 \times 10^{-12}$ )	Input sensitivity $\geq 10$ mV p Input Impedance = ... 300 pF...
p-p	Peak to peak	20 V p-p output capability
s	Second	Update rate = 1 ms ...
V	Volt or voltage	10 mV to 100 V input
$V_U$	Upper-voltage set point	See $f_U$
$V_L$	Lower-voltage set point	See $f_U$
"	Inch	Length = 4"

---

## Section II

# Specifications

---

### GENERAL

All specifications apply over the temperature range of 0°C to 50°C unless otherwise specified, and they are the maximum deviation allowed from ideal unless otherwise noted. Table 1-1 lists the various symbols and their respective meanings that are used throughout this manual.

### INPUT

<b>Configuration</b>	Differential with a common-mode-voltage rating of up to 100 V dc or peak ac.
<b>Impedance</b>	200 kΩ in parallel with 300 pF nominal.
<b>Frequency range</b>	1 Hz to 50 kHz.
<b>Sensitivity and bandwidth</b>	Three steps of input sensitivity and three steps of input-bandwidth control are provided to optimize input signal-to-noise ratio.

**Table 2-1**  
**Input Bandwidth and Sensitivity Settings**

Screen	MIN	MID	MAX
Input B/W	10 Hz	500 Hz	Wideband
Input Sensitivity	0 V to 100 V	0 V to 25 V	0 V to 5 V
All settings are nominal.			

<b>Periodic-error filtering</b>	A periodic-error filter can be activated for input signals that are less than 1 kHz. By entering the pulses per revolution (cycle), the user can eliminate erroneous variations of periodicity. Two to 999 pulses can be accommodated.
<b>Pulse width</b>	5 μs minimum.

### OUTPUT

<b>Voltage (V)</b>	The linear range of the analog output is from -10 V to +10 V with up to 10 mA current. The output limits are approximately ±10.5 V. Output voltage for a given frequency is determined by voltage and frequency set points using the following:
--------------------	---

$$V = \frac{V_U - V_L}{f_U - f_L} \times (f_{in} - f_L) + V_L,$$

where  $f_{in}$  is the input frequency and  $V_U$  and  $V_L$  and  $f_U$  and  $f_L$  are the upper and lower voltage and frequency settings of the instrument, respectively.

**Uncertainty ( $V_{UNC}$ )**

For frequencies less than 1 kHz,

$$V_{UNC} = 0.00122 + \left[ \frac{f_{in}^2}{1.5 \times 10^6 - f_{in}} \times \frac{V_U - V_L}{f_U - f_L} \right],$$

where  $f_{in}$  is the input frequency and  $V_U$  and  $V_L$  and  $f_U$  and  $f_L$  are the upper and lower voltage and frequency settings of the instrument, respectively.

For frequencies of 1 kHz and above,

$$V_{UNC} = 0.00122 + \left[ \frac{f_{in}^2}{(1.5 \times 10^6)F} \times \frac{V_U - V_L}{f_U - f_L} \right],$$

where  $f_{in}$  is the input frequency,  $F$  is  $f_{in}/1000$  rounded up to the nearest integer, and  $V_U$  and  $V_L$  and  $f_U$  and  $f_L$  are the upper and lower voltage and frequency settings of the instrument, respectively.

**Uncertainty (Hz)**

The uncertainty of the output in terms of frequency is

$$Hz = V_{UNC} \times \frac{f_U - f_L}{V_U - V_L},$$

where  $V_{UNC}$  is the uncertainty in volts, and  $V_U$  and  $V_L$  and  $f_U$  and  $f_L$  are the upper and lower voltage and frequency settings of the instrument, respectively.

**Scaling  $\left( \frac{V}{Hz} \right)$**

$$\frac{V}{Hz} = \frac{V_U - V_L}{f_U - f_L},$$

where  $V_U$  and  $V_L$  and  $f_U$  and  $f_L$  are the upper and lower voltage and frequency settings of the instrument, respectively.

**Resolution (R)**

For input frequencies below 1 kHz, the resolution at the output is:

$$R = 0.00122 \text{ V or } \left( \frac{f_{in}^2}{1.5 \times 10^6 - f_{in}} \times \frac{V_U - V_L}{f_U - f_L} \right),$$

whichever is greater, where  $f_{in}$  is the input frequency,  $V_U$  and  $V_L$  are the voltage settings, and  $f_U$  and  $f_L$  are the frequency settings.

For input frequencies at or above 1 kHz, resolution in volts at the output is:

$$0.00122 \text{ V or } \left( \frac{f_{in}^2}{(1.5 \times 10^6)F} \times \frac{V_U - V_L}{f_U - f_L} \right),$$

whichever is greater, where  $f_{in}$  is the input frequency,  $F$  is  $f_{in}/1000$  rounded up to the nearest integer,  $V_U$  and  $V_L$  are the voltage settings, and  $f_U$  and  $f_L$  are the frequency settings.

<b>Impedance</b>	Less than 1 $\Omega$ at dc.
<b>Response time</b>	Response to an abrupt frequency change is $0.005 \text{ s} + \frac{1}{f_{in}}$ , where $f_{in}$ is the frequency of the input, with the filter set to wideband. For other filter frequencies, add $\frac{5}{f_{co}}$ , where $f_{co}$ is the filter cutoff frequency.
<b>Update rate</b>	0.001 s or $\frac{1}{f_{in}}$ , where $f_{in}$ is the frequency of the input, whichever is a longer period of time.
<b>Latency</b>	The output will start to respond to a change in input frequency within 1 ms of each falling edge of the input signal for input frequencies above 1 kHz and within $1 \text{ ms} + \frac{1}{f_{in}}$ , where $f_{in}$ is the frequency of the input, for frequencies below 1 kHz.
<b>Filter</b>	Selectable filter frequencies of 1 Hz, 10 Hz, and 100 Hz plus wideband (approximately 1.5 kHz). The filter has a two-pole Bessel characteristic.

## **FREQUENCY-TO-VOLTAGE CONVERSION**

<b>General</b>	Following the input circuit, a microcontroller converts the input frequency to an equivalent analog signal. The output is then scaled to a 14-bit DAC based on the user-specified frequency and voltage set points.
<b>Frequency set points (upper and lower)</b>	These set points determine the input frequency at which the upper- and lower-voltage set points are reached. The frequency set points can be any two frequencies between 0 Hz and 50 kHz with a resolution of 1 Hz, and they can be within 10 Hz of each other.
<b>Voltage set points (upper and lower)</b>	These set points determine the output voltages corresponding to the upper- and lower-frequency set points, respectively. The voltage set points can be any two voltages from -10 V to +10 V with a resolution of 0.1 V, and they can be within 0.1 V of each other (the upper-voltage set point always being more positive than the lower voltage set point).

## **CALIBRATION**

When in the calibration mode, an internally generated calibration signal can be set to any frequency between 1 Hz and 50 kHz in 1 Hz increments. When enabled, the analog output assumes a value according to the frequency and voltage set points. The calibration signal can be toggled on and off when in the CAL mode of operation.

**ALIGNMENT**

Alignment of the Model 441AL is performed using the two alignment modes of  $-10$  V and  $+10$  V. This feature allows field alignment and calibration of the instrument using only a voltmeter.

**FRONT PANEL****Controls**

The display/push button allows the operator to sequence through the various setup screens. The round switch, encoder, has both push-button and rotary action: the push-button action moves the cursor to the digit to be changed while the rotary action is used to change the selected digit. All operating parameters are set using these controls and are shown on the display.

**Input LED**

The LED on the front panel indicates that a valid input frequency signal is present and that the output represents the input frequency.

**Display**

The front-panel back-lit LCD display shows the input frequency when in the operate mode. Five digits of resolution are indicated — even at lower frequencies. If the input frequency is unstable the less-significant digits will vary. Table 2-2 lists all possible screens and their functions.

**RETENTION OF SETTINGS**

All settings of the Model 441AL are retained in nonvolatile memory.

**INPUT POWER****Range**

10.5 V dc to 32 V dc, unregulated.

**Over-voltage protection**

Up to  $+60$  V for 15 s;  $+32$  V and  $-50$  V, continuously.

**Current (nominal)**

150 mA.

**Protection**

Protected against polarity reversal.

**ENVIRONMENT****Emi/rfi**

Internal rfi filters are provided on all connector leads.

**Operating temperature**

$0^{\circ}\text{C}$  to  $+50^{\circ}\text{C}$ .

**Storage temperature**

$-40^{\circ}\text{C}$  to  $+80^{\circ}\text{C}$ .

**Altitude**

No limit with adequate heat dissipation.

**Static-acceleration  
resistance**

$200\text{ m/s}^2$  (approximately 20 g) in any plane.

**Shock resistance**

$200\text{ m/s}^2$  (approximately 20 g) for 11 ms in any plane.

**Vibration resistance**

$100\text{ m/s}^2$  (approximately 10 g) in any plane.

**DIMENSIONS (SEE DRAWING 441-900)**

<b>Height (panel)</b>	60.2 mm (2.37").
<b>Height (case)</b>	50.8 mm (2.00").
<b>Width</b>	28.4 mm (1.12").
<b>Depth</b>	101.6 mm (4.00").
<b>Weight</b>	255 g (9 oz) nominal.

**COMPATIBILITY**

The Model 441AL will operate in all standard Ectron enclosures designed for Models 352 and 428 conditioner-amplifiers and the Model 451 LVDT-signal conditioner. Current enclosure products are Models E408-1, E408-6Y, and R408-14Y.

**Table 2-2  
Front-panel Screens**

<b>Screen</b>	<b>Function</b>
Operate	Default screen; input frequency ( $f_{in}$ ) and pulses per revolution are displayed.
$f_U$ and $f_L$ set points	Select $f_U$ and $f_L$ between 0 Hz and 50 kHz.
$V_U$ and $V_L$ set points	Select $V_U$ and $V_L$ between -10 V and +10 V.
Pulses/revolution	Select pulses per revolution for input signal less than 1 kHz to eliminate periodic error. This function can be turned OFF and ON.
Input sensitivity	Select input-voltage sensitivity of MIN (100 V peak), MID (25 V p), MAX (10 V p).
Input bandwidth	Select input bandwidth of MIN (10 Hz), MID (500 Hz), MAX (WB).
Output filter	Select output-filter frequency of 1 Hz, 10 Hz, 100 Hz, or WB.
Calibration	Select calibration frequency between 1 Hz and 50 kHz and turn calibration ON or OFF.
Viewing angle	Set screen for best visibility.
Alignment, -10 V	Alignment between internal analog and digital components.
Alignment, +10 V	
Memory error	Appears only when there is a memory error.
Alignment required	Appears only when alignment is required.
Reset	Allow user to reset all parameters to the default settings.
Reset (momentary)	Appears for one second after a reset.



---

## Section III

# Operation

---

### GENERAL

In this section, connections to the Model 441AL and the use of its controls are discussed. The name frequency-to-voltage converter is somewhat misleading in that the real value of this instrument lies not in its ability to measure frequency—instruments dedicated to that task do it better—and produce a corresponding voltage output—some frequency-measuring instruments do this, too—but in its ability to rapidly respond to changes in frequency and faithfully to produce a corresponding voltage. A more suitable name for the product then could be “a change in frequency producing a corresponding change in voltage” converter. This is awkward, so we shorten it.

### CONNECTIONS

The Model 441AL uses a “D” subminiature fifteen-pin connector for all input and output connections. Table 3-1 summarizes these connections. These pin assignments are the same as for Ectron Models 352 and 428 conditioner-amplifiers. Therefore, unless special features have been incorporated that would preclude using the Model 441AL, enclosures designed for these amplifiers are compatible with the Model 441AL including Models E408 and R408. The Model 441AL accepts power from 10.5 V dc to 32 V dc, so enclosures designed for either 12 V dc or 28 V dc can be used.

**Table 3-1**  
**Connector-pin Assignments**

Pin	Function	Pin	Function	Pin	Function
1	Input high	6	---	11	Output low
2	Input low	7*	Power high	12	---
3	Digital output high	8*		13	Case ground
4	Analog output high	9	Input guard	14	---
5	---	10	---	15	Power low

\* Pins 7 and 8 are internally connected.

### OPERATIONAL-STATE DIAGRAM

Figure 3-1 is the operational-state diagram for the Model 441AL. Starting at the top of the diagram all possible screens and operator choices at these screens are depicted. Additionally, it shows decisions made by the unit during normal operation. These decisions are diagnostic in nature; and if an error (such as a memory error) occurs, the user will be notified on the screen of the event.

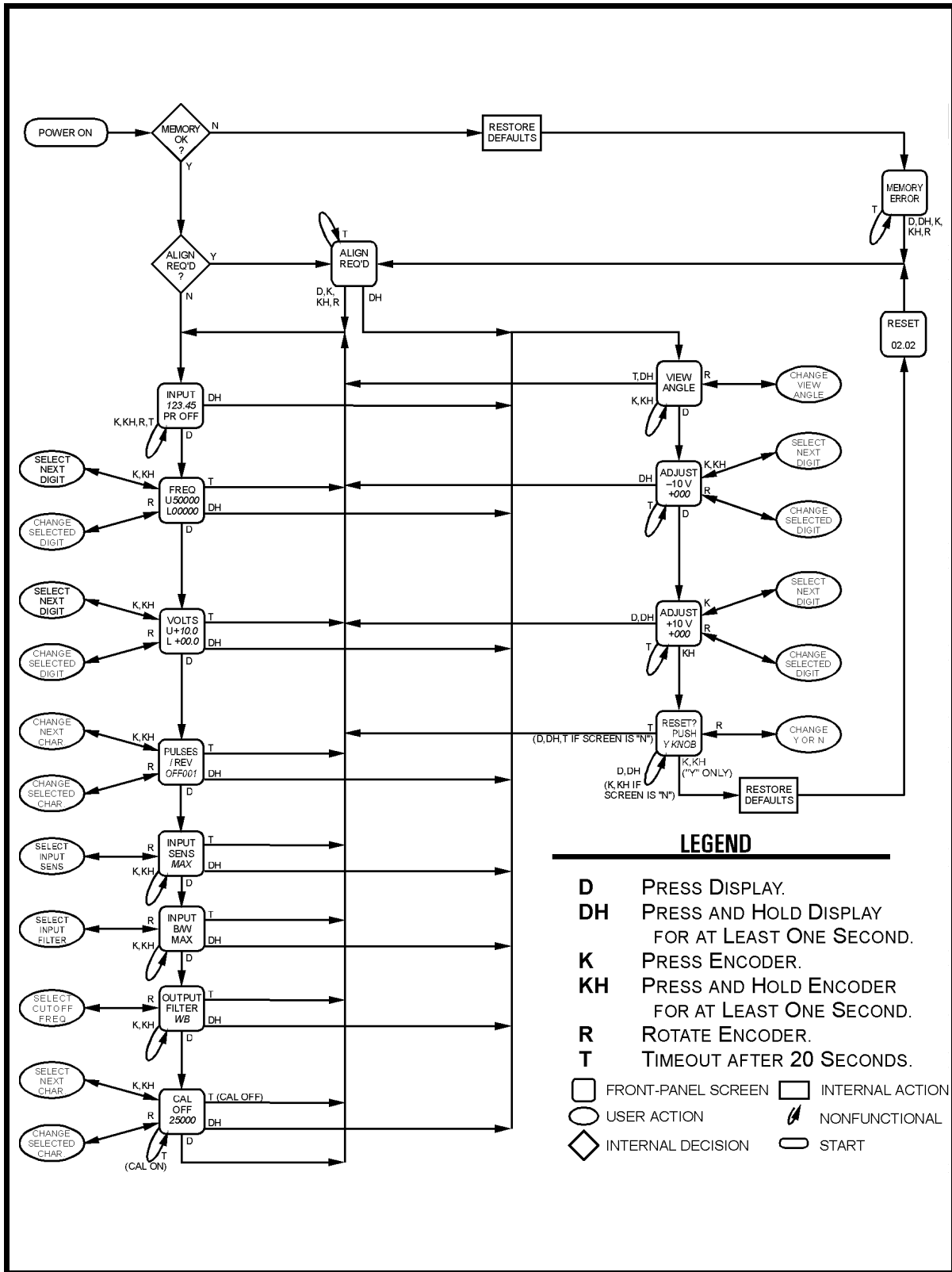

Figure 3-1  
Operational-state Diagram

**Table 3-2  
Default Settings and Limits**

<b>Function</b>	<b>Parameter</b>	<b>Default Setting</b>	<b>Screen Limits</b>
Frequency	Upper set point	50000 Hz	10 Hz to 50000 Hz and 10 Hz higher than the lower-frequency set point
	Lower set point	0 Hz	0 Hz to 49990 Hz and 10 Hz lower than the upper-frequency set point
Voltage	Upper set point	+10.0 V	-9.9 V to +10 V and 0.1 V higher than the lower-voltage set point
	Lower set point	0 V	-10 V to +9.9 V and 0.1 V lower than the upper-voltage set point
Pulses/revolution	ON/OFF	OFF	ON, OFF
	Pulses	001	001-999
Input sensitivity	Voltage	MAX	MIN, MID, MAX
Input filter	Frequency	MAX	MIN, MID, MAX
Output filter	Frequency	WB (wideband)	1 Hz, 10 Hz, 100 Hz plus WB
CAL	ON/OFF	OFF	ON, OFF
	Frequency	25,000 Hz	0 Hz to 50,000 Hz
Alignment	-10 V	+000	±750 counts
	+10 V	+000	±750 counts
View angle	Contrast	Midrange	Black & blank
Reset	Default settings	NO	YES, NO

**LIMITS VS SETTINGS**

In setting the controls so that a certain frequency corresponds to a certain voltage and another higher frequency corresponds to a higher (more positive) voltage, the user should always remember that these set points do *not* set the limits of operation. Rather they determine the volts-per-hertz scaling of the output. The limits are fixed at 0 Hz to 63 kHz and -11 V to +11 V. Table 3-2 lists the default settings and limits for the Model 441AL. Except for voltage alignment, these are the settings of a new unit, and they are the settings (including voltage alignment) when a **RESET** is performed. New units are aligned when shipped.

**Figure 3-2**  
**View Angle**  
**Normal and extreme**  
**view angles**

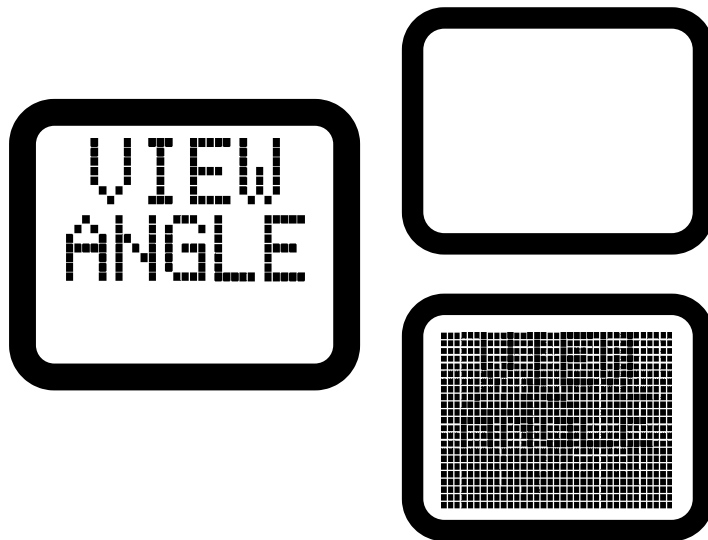

**VIEW ANGLE**

Although this screen is actually considered a secondary screen, accessed by pressing and holding the display for more than one second, it is discussed first because the possibility exists that if the instrument is in an extreme-temperature environment, the screen will not be visible when the unit is energized. It may be black or it may be blank. If this occurs, press and hold the display for more than one second, and then rotate (counterclockwise if too dark, and clockwise if too light) the encoder (round knob) until the words **VIEW ANGLE** are visible.

At this point, the user can either wait approximately twenty seconds (or press the display twice or press and hold the display for more than one second) to return to the operate screen.

**CONTROLLING THE MODEL 441AL**

The controls on the front panel consist of a display, which has the additional function of screen selection, and the encoder, which has the dual function of character selection and control. Using these two controls is all that is necessary to fully operate the Model 441AL.

**Display**

As stated above, the display has the dual function of display and screen selection. There are two ways to select a screen. One is to press and release. This selects

the screens that the user would typically access while operating the Model 441AL. The other is to press and hold the display for more than one second. This evokes a set of secondary screens to set parameters less frequently changed.

### **Encoder**

The round encoder has the dual function of character selection and control. Once a screen has been selected, a blinking cursor will appear that will cover one or more characters. The cursor always first appears on the top left-most character. Pressing the encoder moves the cursor across the screen and down through all the changeable characters and back to the top left. If the user inadvertently steps past the character to be changed, simply continue pressing the encoder until the cursor is where he or she wants it to be.

Once the character to change has been selected, rotate the encoder either clockwise or counterclockwise until the character is correct. When changing numbers, rotating the encoder can change digits to either side of the digit being changed. For example, if the user is changing one of the voltage set points, and the cursor is on the tenths digit, then changing it from 9 to 0 will increment the ones digit. The user should remember that the Model 441AL screen values will not violate the limits shown in Table 3-2. If he or she is rotating the encoder and the character under the cursor is not changing as expected, the most likely cause is that the Model 441AL is being asked to exceed a limit.

The encoder has two additional functions when the user wants to reset the default parameters. When at the screen to align +10 V, pressing and holding the encoder for more than one second evokes the **RESET** screen, which gives the user the opportunity to perform a reset. If the user then chooses **Yes** and presses the encoder, a reset is performed.

Once a character has been changed, and the operate screen restored, the nonvolatile memory is updated with the new information. However, if power is interrupted between the time of character change and return to the **OPERATE** screen, *memory is not updated.*

The following paragraphs discuss all the screens of the Model 441AL. How to get to each screen from the operate screen, how to set each screen, and how to return to the operate screen are presented.

**Figure 3-3**

**Operate**  
Input frequency of 123.45 Hz  
and PR set to 96

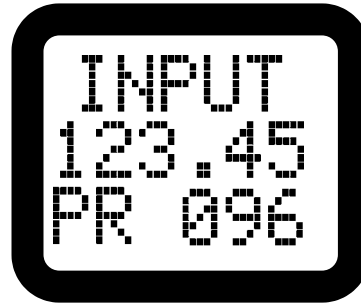

**OPERATE SCREEN**

When the Model 441AL is energized this screen is normally displayed. When the green light is on, the number on the screen is the frequency of the input signal. It can be any frequency from 1 Hz to 63 kHz. Below 1 Hz, zeroes are displayed; above 63 kHz, dashes are displayed. Full floating-point presentation is employed. Also displayed is **PR** (pulses per revolution) and the current setting of the pulses-per-revolution (digital periodic-error) filter.

**Figure 3-4**

**Frequency Set**  
Upper-frequency set point  
of 16,475 Hz and a lower-  
frequency set point  
of 9832 Hz



**FREQUENCY-SET SCREEN**

<b>Function</b>	To set the upper- and lower-frequency set points.
<b>From the OPERATE screen</b>	Press the display once.
<b>To the OPERATE screen</b>	Press the display seven times or wait approximately twenty seconds.
<b>Defaults</b>	<b>50000</b> Hz and <b>00000</b> Hz.
<b>Discussion</b>	The upper-frequency set point can be any frequency from 10 Hz to 50 kHz while the lower-frequency set point can be any frequency from 0 Hz to 49,990 Hz.
<b>Operation</b>	There are ten possible characters to set on this screen. When the screen is first displayed, the blinking cursor is on the 10,000's digit of the upper-frequency set point. Press (and release) the encoder until the cursor is at the

digit to be changed. Then, rotate the encoder until that digit is set. Continue until all the digits are set. Remember that the two frequencies can never be closer to each other than 10 Hz.

**Figure 3-5**  
**Voltage Set**  
 Upper-voltage set point of +3.4 V and a lower-voltage set point -1.7 V

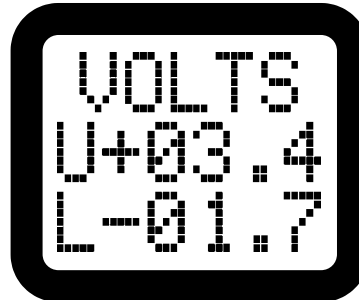

**VOLTAGE-SET SCREEN**

<b>Function</b>	To set the upper- and lower-voltage set points.
<b>From the OPERATE screen</b>	Press the display twice.
<b>To the OPERATE screen</b>	Press the display six times or wait approximately twenty seconds.
<b>Defaults</b>	<b>+10.0 V</b> and <b>+00.0 V</b> .
<b>Discussion</b>	The upper-voltage set point can be any voltage from -9.9 V to +10.0 V while the lower-voltage set point can be any voltage from -10 V to +9.9 V.
<b>Operation</b>	There are four possible characters to set on this screen. When the screen is first displayed, the blinking cursor is on the 1's digit of the upper-voltage set point. Press (and release) the encoder until the cursor is at the digit to be changed. Then, rotate the encoder until that digit is set. Continue until all the digits are set. Remember that the two voltages cannot be closer to each other than 0.1 V.

**INPUT-SIGNAL SCREENS**

There are three screens to filter and condition the input signal to enhance the performance of the Model 441AL. The first, **PULSES/REV**olution, eliminates input-signal error due to periodic, repetitive variations or errors. The next two screens, **INPUT SENS**itivity and **INPUT B/W**, work in conjunction with each other to provide the user nine combinations of input conditioning for the input signal. See the Applications section for further discussion.

**Pulses/Revolution Screen**

<b>Function</b>	To set the number of pulses of the input signal that occur during one revolution (or cycle).
<b>From the OPERATE screen</b>	Press the display three times.

Figure 3-6

Pulses/Rev

P/R set ON and number of pulses set to 96

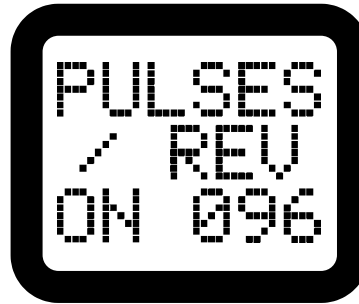

To the OPERATE screen

Press the display five times or wait approximately twenty seconds.

Default

OFF, 001.

Discussion

The pulses/revolution filter can be set **ON** or **OFF**, and the number of pulses can be set from **1** to **999**. Note that even though the **PULSES/REV** has been turned **ON**, this function ceases to operate when the input signal is outside the range of 1 Hz to 1 kHz (i. e. the time between two consecutive input pulses is less than 1 ms or greater than 1 s). It will reactivate automatically if and when the input signal returns to within that range. Once this digital filter has been turned **ON** or internally reactivated, one revolution must occur before the output of the Model 441AL is averaged.

Operation

Pressing the encoder moves the cursor from one character to the next, (**ON** or **OFF** is the first choice). Then rotate the encoder for the number of pulses per cycle.

Figure 3-7

Input Sensitivity

Input sensitivity set to MAX

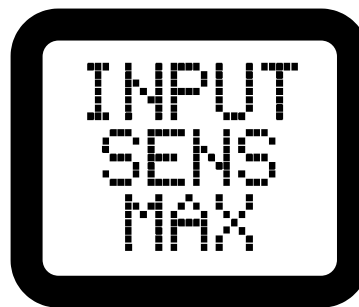

Input-sensitivity Screen

Function

To set the input-voltage sensitivity.

From the OPERATE screen

Press the display four times.

To the OPERATE screen

Press the display four times or wait approximately twenty seconds.

Default

MAX.



**Discussion**

The input sensitivity can be set to **MIN**, **MID**, or **MAX**.

**Operation**

Since there is only one character to change on this screen, the encoder push-button action has no function. Simply rotate the encoder to select the desired sensitivity.

**Figure 3-8**  
**Input bandwidth**  
**Input bandwidth**  
**set to MID (midrange)**

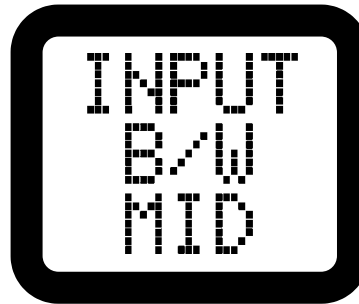

**Input-B/W (Filter) Screen**

**Function**

To select the input filter.

**From the OPERATE screen**

Press the display five times.

**To the OPERATE screen**

Press the display three times or wait approximately twenty seconds.

**Default**

**MAX.**

**Discussion**

The input bandwidth can be set to **MIN**, **MID**, or **MAX**.

**Operation**

Since there is only one character to change on this screen, the encoder push-button action has no function. Simply rotate the encoder to select the desired filter.

**Figure 3-9**  
**Output filter**  
**Output filter**  
**cutoff frequency**  
**of 100 Hz**

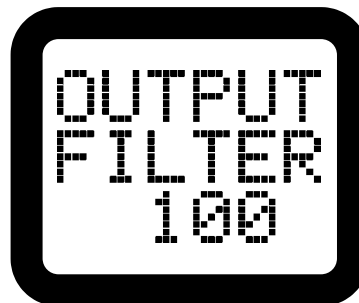

**OUTPUT-FILTER SCREEN**

**Function**

To set the output filter.

**From the OPERATE screen**

Press the display six times.

**To the OPERATE screen**

Press the display twice or wait approximately twenty seconds.

<b>Default</b>	<b>WB</b> (wideband).
<b>Discussion</b>	The filter can be set to <b>1 Hz</b> , <b>10 Hz</b> , <b>100 Hz</b> , or <b>WB</b> , which is approximately 1.5 kHz.
<b>Operation</b>	Since there is only one character to change on this screen, the encoder push-button action has no function. Simply rotate the encoder to select the desired filter.

**Figure 3-10**  
**CAL screen**  
**CAL “on”**  
**and CAL frequency**  
**set to 12.5 kHz**



## **CAL SCREEN**

<b>Function</b>	To set the calibration frequency.
<b>From the operate screen</b>	Press the display seven times.
<b>To the operate screen</b>	Press the display once or wait approximately twenty seconds.
<b>Defaults</b>	<b>OFF, 25000 Hz.</b>
<b>Discussion</b>	The calibration frequency is used in conjunction with the upper and lower set points of frequency and voltage. It simulates the frequency and puts out the corresponding voltage when <b>ON</b> . For example, if the user has frequency set points of 1 kHz and 2 kHz and voltage set points of 1 V and 2 V, he or she may want to set a <b>CAL</b> frequency of either the upper or lower frequency set points or perhaps the midpoint, 1.5 kHz. This is not to say that the cal frequency must be within the frequency set points.
<b>Operation</b>	First, set the <b>CAL</b> function to <b>ON</b> or <b>OFF</b> by rotating the encoder, select the digit or digits to be set using the push-button function of the encoder, and then set them with the rotary function.

## **SECONDARY SCREENS**

Access to these screens, **VIEW ANGLE** and **±10 V ALIGNMENT** is by pressing and holding the display while at any of the primary displays. The sequence is **VIEW ANGLE**, **-10 V ALIGNMENT**, and **+10 V ALIGNMENT**. Adjustment of **VIEW ANGLE** is discussed on Page 3-4.

**Figure 3-11**  
Adjust +10 V  
screen used  
to align the out-  
put with internal  
software



## Ten-volt Alignment

### Function

The alignment screens allow the operator to align the output of the Model 441AL with its internal software using a voltmeter.

### From the OPERATE screen

Press and hold the display for more than one second and then press the display once for negative 10 V alignment and twice for positive 10 V alignment.

### To the OPERATE screen

From the negative 10 V alignment screen, press the display twice; from the positive 10 V screen, once.

### Default

**+000.**

### Operation.

When at the negative 10 V alignment screen, connect a DMM to the output of the Model 441AL and then using the encoder, adjust the output for  $-10\text{ V} \pm 0.005\text{ V}$ . Next press the display once to go to positive 10 V alignment screen and adjust the encoder for  $+10\text{ V} \pm 0.005\text{ V}$ . The three-digit number on each display is a reference number for the convenience of the user. The user may want to note the readings once the alignment is made. Then if an alignment is required in the future and a voltmeter is unavailable, the user can simply reset the numbers to those noted above with confidence that the unit is properly aligned.

There are four additional secondary screens: **MEMORY ERROR**, **RESET**, **ALIGNMENT REQUIRED**, and a temporary screen seen only after a reset is made.

**Figure 3-12**

The **ALIGNMENT REQUIRED** screen will appear so long as  $\pm 10\text{ V}$  alignment is necessary. The displayed digits are for factory use.



**Figure 3-13**  
**The MEMORY-ERROR screen will appear if an error in nonvolatile memory occurs.**

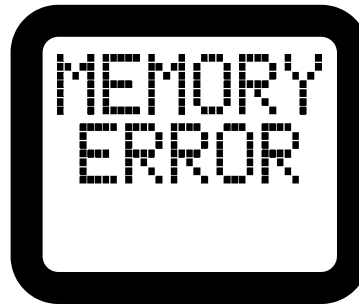

**MEMORY ERROR** is inaccessible by the user and will normally never be seen. As is shown in Figure 3-1, each time the Model 441AL is energized, nonvolatile memory is tested. Normally, it will pass the test and will immediately display the **OPERATE** screen. However, should a memory error occur, the **MEMORY ERROR** screen will be displayed. To advance past this screen, press the display or press or turn the encoder. The Model 441AL will then restore the default settings (Table 3-2) and go to the **ALIGNMENT REQUIRED** screen. Again the operator can press the display or press or turn the encoder, and the unit will advance to the **OPERATE** screen. Until the two 10 V alignments are performed, the unit will stop at the **ALIGNMENT REQUIRED** screen each time power is applied.

If the user chooses, the default settings can be restored by going to the **RESET** screen and selecting **Y** (yes) **PUSH KNOB**.

**Figure 3-14**  
**Use the RESET screen to restore the default parameters.**

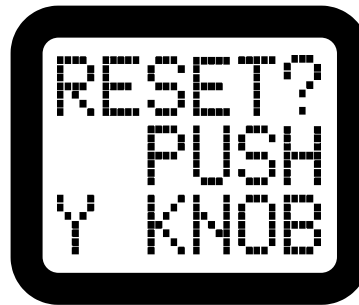

**Reset**

- |   |   |
|---|---|
| <b>Function</b>   | To restore the default settings.  |
| <b>From the OPERATE screen</b>  | Press and hold the display until <b>VIEW ANGLE</b> is displayed, press the display twice more (plus 10 V alignment), and then press and hold the encoder for one second or more.  |
| <b>To return to the OPERATE screen (without having performed a reset)</b> | Press the display when the screen displays <b>N</b> (no) <b>PUSH DISPLAY</b> or wait 20 seconds.  |
| <b>To return to the OPERATE screen (having performed a reset)</b>         | Press the encoder when the screen displays <b>Y</b> (yes) <b>PUSH KNOB</b> . As shown in the operational-state diagram, the operate screen is displayed only after a momentary <b>RESET</b> screen and the alignment-required |

---

	screen has been cleared by pressing the display or pressing or turning the encoder.
<b>Operation</b>	Rotate the encoder to select <b>Y</b> (yes) <b>PUSH KNOB</b> or <b>N</b> (no) <b>PUSH DISPLAY</b> .
<b>Discussion</b>	Only when the user has selected <b>Y PUSH KNOB</b> and has pressed the encoder will a reset be performed. Then the unit will display the <b>ALIGNMENT REQUIRED</b> screen, and the user can proceed as previously described.

## **ENCLOSURES**

### **Model E408-1**

The Model E408-1 is a single-unit mount designed to mount directly to a bulkhead or to a DIN rail (Option D). It can be mounted on three of its six sides with screws (10-32 machine screws are recommended) in any aspect. The installed unit can be right-side up or down within the mount as well. A right-angle hooded DAM-15S connector is provided for cabling. The hooded shell can be mounted right-side up or down, too, depending on where the user would like the cabling to exit. Drawing 408-900 shows all unit dimensions as well as mounting dimensions.

### **Model E408-6**

The Model E408-6 enclosure is a six-channel bench-top unit, which will hold Models 352, 428, 441A, 441AL, and 451 in any combination. Being small, lightweight, and powered either by ac or dc, the enclosure is well suited for use in the field as well as the laboratory.

#### **Features**

- Inside the top cover, which is held on by four captive screws, are terminals for each channel for bridge completion, CAL, and bridge balance (for Model 352).
- Channel-input and dc-power connectors are PT series, and output connectors are BNC. An ac power cord and mating connectors for all but the BNC's are provided.
- Front-panel controls include power on-off (for ac and externally applied dc); ALL ZERO for Model 428 equipped with autozero (Option O); and CAL with positions of +, -, and OPR (operate), which is functional when a CAL resistor and any bridge configuration are installed or connected. Calibration is input shunt calibration by means of electronically switching a customer-installed CAL resistor in parallel with selected arms of the bridge to produce either a plus or a minus calibration.
- Also included are provisions for bridge balance for units so equipped and output frequency-response control for Model 352 amplifier-conditioners.
- As with all Ectron enclosures, the Model E408-6 does not degrade any plug-in specifications.

- Model E408-6Y has an internal 12 V dc power supply, and the E408-6X has a power supply of 28 V dc.
- When setting up the Model E408-6 for operation, refer to either Drawing 408-600 (for 12 V dc systems) or 408-601 (28 V dc systems) at the rear of this manual for settings of plug jumper W1 (W2 is not active when using the Model 441AL in this enclosure). Also depicted are typical input configurations the customer may want to use.

### **Model R408-14**

The Model R408-14 enclosure is a 14-channel 3- $\frac{1}{2}$ -inch-high, 19-inch-wide rack-mount unit that holds Models 352, 428, 441A, 441AL, and 451 in any combination. It also is powered by either dc or ac and comes in both 12 V dc (Option Y) and 28 V dc (Option X) versions.

#### **Features**

- Beneath the top cover are terminals for each channel for bridge completion, CAL, and bridge balance (for Model 352).
- Channel-input and dc-power connectors are PT series, and output connectors are BNC. An ac power cord and mating connectors for all but the BNC's are provided.
- Front-panel controls include power on-off (for ac and externally applied dc); ALL ZERO for Model 428 equipped with autozero (Option O); and CAL with positions of +, -, and OPR (operate), which is functional when a CAL resistor and any bridge configuration are installed or connected. Calibration is input shunt calibration by means of electronically switching a customer-installed CAL resistor in parallel with selected arms of the bridge to produce either a plus or a minus calibration.
- Also included are provisions for bridge balance for units so equipped and output frequency-response control for Model 352 amplifier-conditioners.
- As with all Ectron enclosures, the Model R408-14 does not degrade the specifications of any plug-in.
- Model R408-14Y has an internal 12 V dc power supply, and the R408-14X has a power supply of 28 V dc.
- When setting up the Model R408-14 for operation, refer to either Drawing 408-605 (for 12 V dc systems) or 408-606 (28 V dc systems) at the rear of this manual for settings of plug jumper W1 (W2 is not active when using the Model 441AL in this enclosure). Also depicted are typical input configurations the customer may want to use.

---

## Section IV

# Applications

---

### GENERAL

To best understand how to apply the Model 441AL, it is important to know some characteristics of its design. This information is available in Section V, Theory of Operation, where some of the features of the design as they apply to application of this product are covered.

### INPUT-SIGNAL CONDITIONER

The job of the input-conditioner section of this instrument is to accommodate input signals with frequencies from 1 Hz to 50 kHz and amplitudes from 5 V peak to 100 V peak. This must be accomplished such that the frequency integrity of the input signal is carefully maintained, even while short-term frequency variations occur. Furthermore, the input must be adaptable to many signal sources and grounding conditions.

To minimize ground-loop problems the input was made differential and isolated from case and power ground. Although signal levels are several-orders-of-magnitude greater than those of transducer amplifiers, noise effects are still very important if accuracy and response are required. This is because noise on the input signal causes unavoidable jitter in the conversion process. (Filtering reduces this jitter but at a sacrifice of response time.)

Three controls are provided to improve conversion stability. These are a three-step input-sensitivity control, a three-step input-bandwidth control, and a digital periodic filter that eliminates cyclic variations in the input signal.

Square and pulse waveforms will give the most noise-free operation. The duty cycle of pulse signals should be greater than about 5%. Minimum acceptable pulse width is approximately 5  $\mu$ s. Although there is no minimum for rise or fall time, little is gained below about 0.6  $\mu$ s.

### INPUT SIGNAL, GROUNDING, AND SHIELDING

Four independent grounds exist within the Model 441AL. As a result, flexibility exists in adapting this unit to a variety of input signal sources. The available ground systems are:

- Input (two input leads and shield).
- Output (output high and low).
- Dc power (plus and common).
- Case.

Proper use of these grounds will result in lower noise and more accurate data. (See the paragraphs under uncertainty, resolution, and noise in this section.) However, incorrect grounding will increase noise and degrade data accuracy. Some grounding recommendations follow:

#### Input

In any signal system, use only one ground point. This applies to the input and output signal systems. The signal input can be “floated off” ground to 100 V dc or peak ac and grounded anywhere that suits the application. The input-shield pin (Pin 9) should be tied to the signal-source common. Shielding and use of twisted-pair leads are recommended if the electrical environment is poor.

---

<b>Output</b>	The high- and low-output leads can and usually should be grounded at the load device. Depending on the load device, connecting this common to earth ground or dc-power-supply ground can minimize noise.
<b>Power</b>	The negative of the dc power source should be connected to earth or power-line ground. In Ectron enclosures, this is accomplished by proper use of the third-wire-ground pin on the power cord.
<b>Case</b>	Case ground (Pin 5) should be connected to earth or power ground. This is done in Ectron enclosures.

## **EMI PROTECTION**

All connections to the converter go through emi-rfi filters to minimize the effects of rf noise. The filter frequency coverage starts with about  $-3$  dB of attenuation at 1 MHz, increasing to  $-66$  dB at 200 MHz and beyond. Emi-rfi filtering is particularly important in vehicle testing, especially involving an engine where wideband emissions are generally high.

## **FREQUENCY-TO-ANALOG CONVERSION**

The digital section receives the conditioned and shaped input-frequency signal. First, frequency-to-digital conversion takes place followed by digital-to-analog conversion. Both of these digital-domain processes are governed by the user-selected frequency and voltage set points.

## **OUTPUT ANALOG FILTER AND OUTPUT STAGE**

To smooth the resulting analog signal, four user-selectable filter frequencies are available: 1 Hz, 10 Hz, and 100 Hz having second-order Bessel characteristics and a wideband (WB) one-pole filter at approximately 1500 Hz. The analog output stage can drive loads at up to  $\pm 10$  V at 10 mA. A short circuit on the output for an indefinite period will not harm the instrument.

## **FREQUENCY AND VOLTAGE SET POINTS**

The frequency set points determine the input frequency at which the upper- and lower-voltage set points are reached. The frequency set points can be any frequency between 0 Hz and 50 kHz with a resolution of 1 Hz. The two frequency set points can be within 10 Hz.

Similarly, the voltage set points determine the output voltages corresponding to the upper- and lower-frequency set points, respectively. The voltage set points can be any voltage from  $-10$  V to  $+10$  V with a resolution of 0.1 V. The two voltage set points can be within 0.1 V. Table 4-1 illustrates converter operation with hypothetical frequency and voltage set points.



**Table 4-1**  
**Input Frequency vs Output Voltage (Example)**

Frequency set points		Voltage set points	
<i>Upper</i> ( $f_U$ )	2000 Hz	<i>Upper</i> ( $V_U$ )	+5 V
<i>Lower</i> ( $f_L$ )	1000 Hz	<i>Lower</i> ( $V_L$ )	0 V
Input Frequency	Output Voltage	Input Frequency	Output Voltage
1000	0	3500	+10.5*
1500	+2.5	900	-0.5
2000	+5	500	-2.5
3000	+10	0	-5
* The output limits at approximately $\pm 11$ V.			

Should the application require it, the output can be set to provide a bipolar output (e.g., for a certain frequency range the output can be set to go from  $-5.000$  V to  $+5.000$  V). Similarly, the output voltage could be set to be all negative. Note that the higher frequency will always produce the more positive output voltage.

Because the minimum difference between the upper- and lower-frequency settings is 10 Hz, and the minimum difference between the upper- and lower-voltage settings is 0.1 V, it is possible to set  $f_U$  at 1000 Hz and  $f_L$  at 990 Hz,  $V_U$  to 1.0 V and  $V_L = 0.9$  V, thus giving a frequency-to-voltage sensitivity of 100 Hz/V. Exactly the same results would be obtained if the settings were  $f_U = 1500$  Hz,  $f_L = 900$  Hz,  $V_U = 6$  V, and  $V_L = 0$  V. The following section shows that extreme settings can result in poor resolution and noise.

## NOISE

In addition to frequency jitter of the input signal, noise at the output of the Model 441AL will be a combination of input signal noise, waveform character, signal amplitude, and instrument settings. For square and pulse input waveforms, output noise should be well under the 10 mV p-p specification assuming sharp rise times and good pulse-to-pulse frequency and phase stability. Ideally, rise times should be under 5  $\mu$ s to utilize the extraordinary conversion accuracy, resolution, and stability of this instrument. A further source of noise can be grounding problems of input and output signal circuits.

Despite the fact that the amplifier's input is differential, input-to-output cross talk can exist external to the amplifier. Good wiring practices should be followed to minimize this effect (see Page 4-1, INPUT SIGNAL GROUNDING AND SHIELDING).

An additional source of input-to-output crosstalk is an inadequate case ground. All pins of the connector incorporate emf-rfi filters. The capacitors associated with these filters connect to case ground (Pin 5 on the DA connector). Consequently, if no case ground exists, signals from one pin will be coupled to other pins by these capacitors. For example, if a sharp-rise square-wave signal exists on the signal input pins, pulses will be seen on the analog output signal unless a good case ground exists. Ectron enclosures provide such a ground assuming input power, either ac or dc, includes a good ground. Note that neither the input nor output filters of the Model 441AL will have much effect on these feed-through pulses.

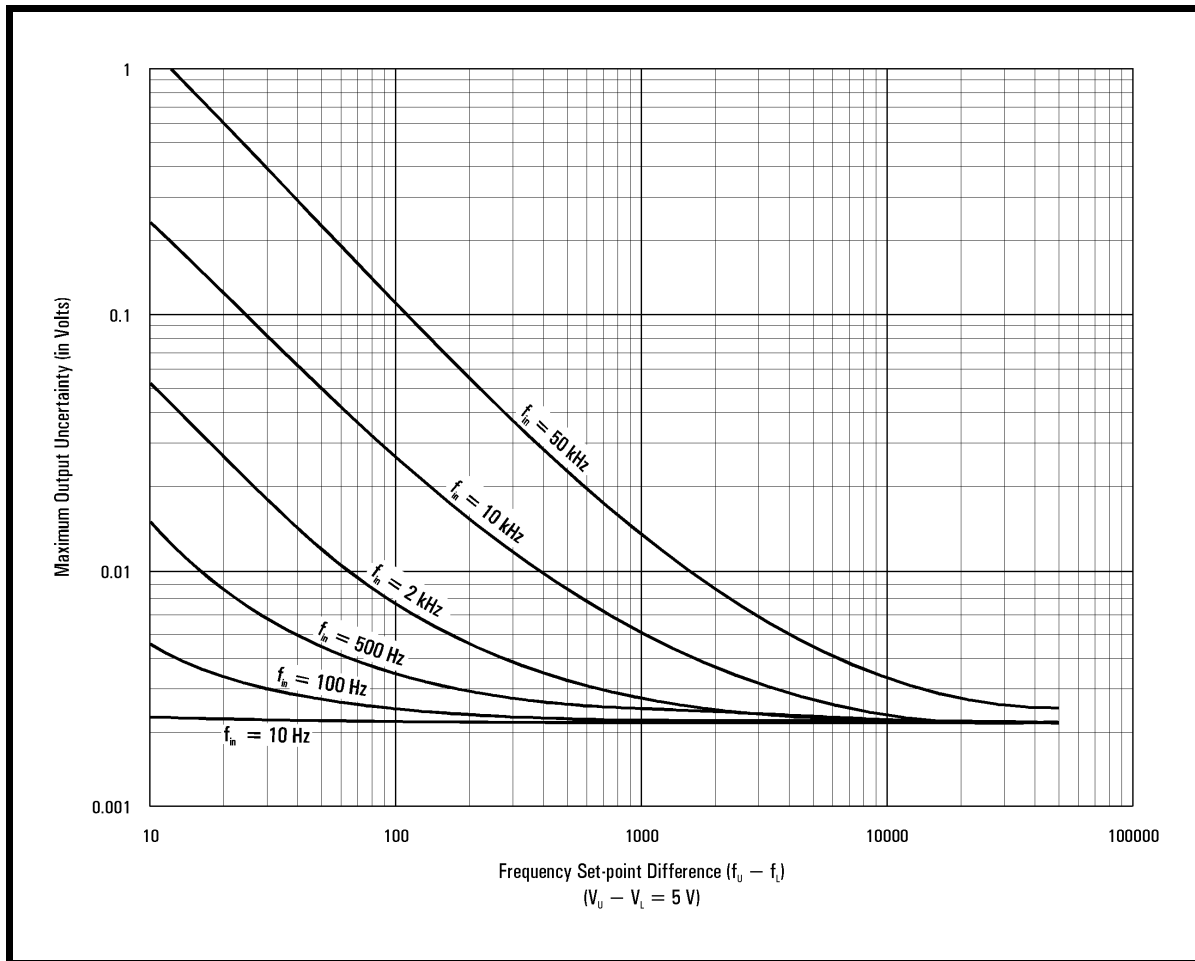

**Figure 4-1**  
**Maximum Uncertainty for Various Frequencies**

To reduce the output noise under difficult input signal conditions, the operator should use as much filtering as possible and should set a wide frequency-set-points difference.

If the input waveform is sawtooth, then output noise will be best if the slow-rise portion of the waveform is positive going, and the abrupt fall is negative going. This is true since the internal conversion circuit of the Model 441AL uses the fall time for triggering.

**UNCERTAINTY AND RESOLUTION**

Output analog uncertainty is within  $\pm 0.00122 + \left[ \frac{(1.5 \times 10^6)f_{in}}{(1.5 \times 10^6) - f_{in}} - f_{in} \right] \times \frac{V_U - V_L}{f_U - f_L}$  for frequencies less than 1 kHz, and  $\pm 0.00122 + \left[ \frac{f_{in}^2}{(1.5 \times 10^6)F} \times \frac{V_U - V_L}{f_U - f_L} \right]$  for frequencies of 1 kHz and above. Output resolution for input frequencies of 1 kHz or below is the greater of 0.0012 V or  $\left( \frac{f_{in}^2}{1.5 \times 10^6} \times \frac{V_U - V_L}{f_U - f_L} \right)$ , resolution for frequencies above 1 kHz is 0.0012 V

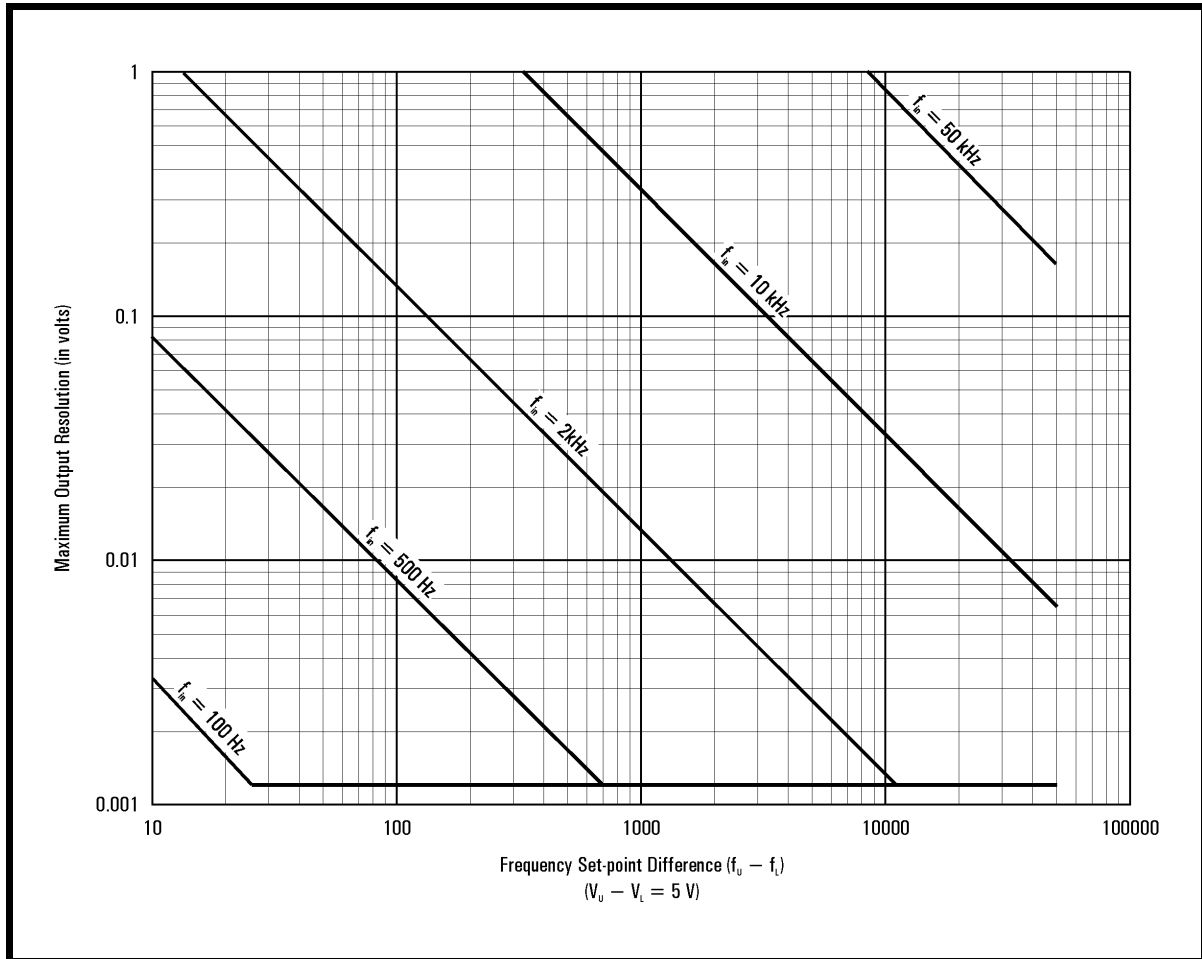

**Figure 4-2**  
**Worst-case Resolution for Various Frequencies**

or  $\left( \frac{f_{in}^2}{1500F} \times \frac{V_U - V_L}{f_U - f_L} \right)$ , and output analog noise is less than 10 mV p-p independent of input frequency measured in a bandwidth of 0.1 Hz to 1 MHz assuming a clean, fast signal.<sup>1</sup> The preferred signal is a square wave or a pulse with fast fall times (the internal detector operates on the negative-going portion of the waveform).

Figures 4-1 through 4-5 illustrate the variation of uncertainty, resolution, and noise for an output of 0 V to 5 V ( $V_L$  to  $V_U$ ). Different input frequencies ( $f_{in}$ ) are plotted against frequency set-points differences ( $f_U - f_L$ ).

Figure 4-1 illustrates the effect on uncertainty of different input frequencies and with different frequency-set-points difference ( $f_U - f_L$ ). Output-voltage set points are assumed to be 0 V and +5 V. Note that for the plot for an input frequency of 10 kHz, uncertainty reaches 0.023 V when ( $f_U - f_L$ ) reaches 100 Hz. This could be for an upper-frequency setting of 10,050 Hz and a lower-frequency setting of 9950 Hz. Even for a frequency setting difference

<sup>1</sup> For the four equations,  $f_{in}$  is the input frequency;  $F$  is  $f_{in}/1000$ , rounded down to the nearest integer;  $V_U$  and  $V_L$  are the upper and lower voltage settings; and  $f_U$  and  $f_L$  are the upper and lower frequency settings.

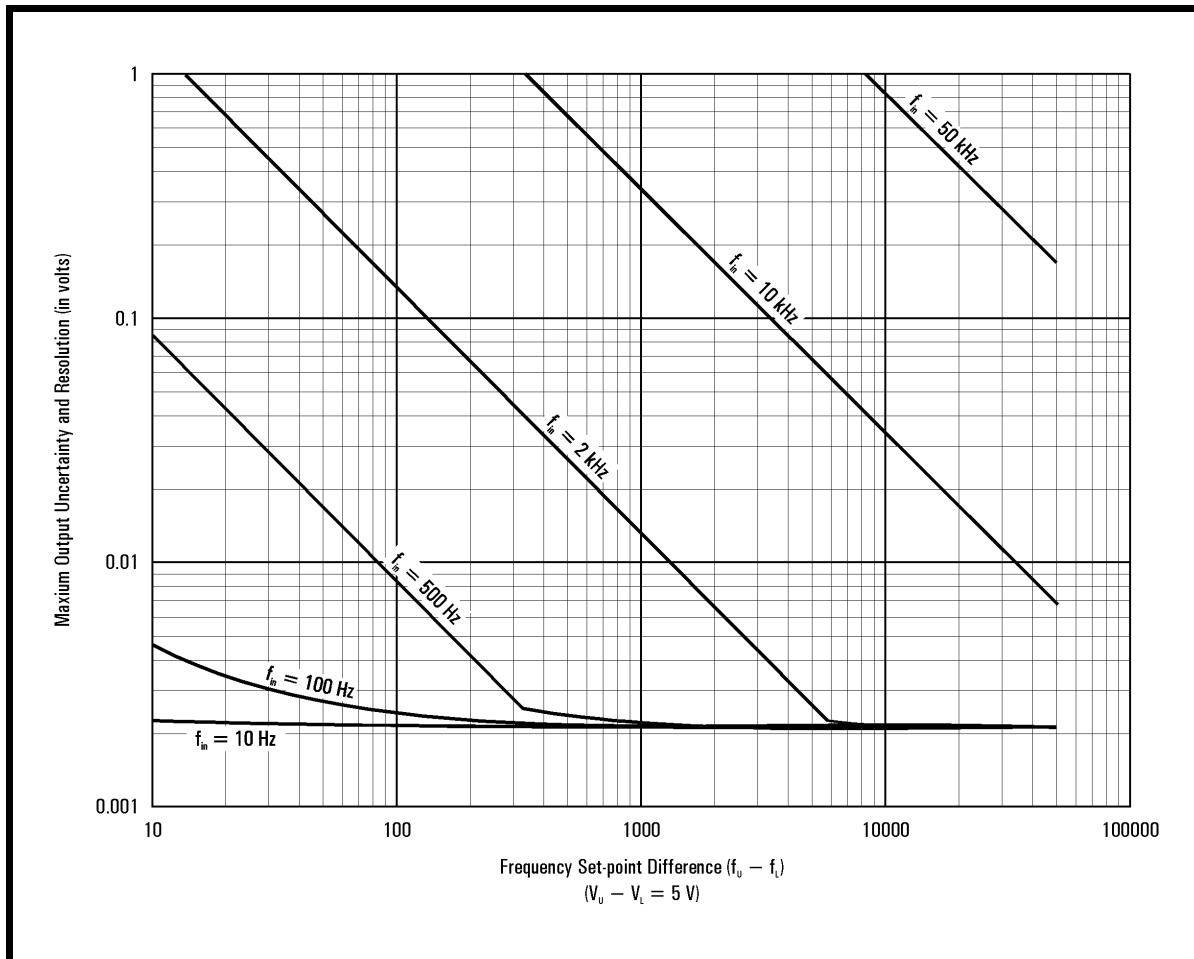

**Figure 4-3**  
**Maximum of Uncertainty and Resolution for Various Frequencies**  
**(Figures 4-1 and 4-2 Combined)**

of 10 Hz, uncertainty at 10 kHz only reaches a total of 0.27 V out of a full scale of 0 V to 5 V.

Figure 4-2 shows that resolution reaches a worst case of 0.015 V for input frequencies of up to 2,000 Hz and a frequency set-points difference of 1000 Hz or higher. Again, output voltage set points are 0 V and +5 V. However, as input frequency increases and the frequency set-points difference decreases, resolution degrades. Fortunately, extreme sets of conditions should seldom occur.

Figure 4-3 is a combination of Figures 4-1 and 4-2 to illustrate the worst case the user can expect at extreme settings.

## FILTERING

There are three types of selectable filters in the Model 441AL: input, output, and periodic-error. The first two are analog low-pass filters, and the last is a digital filter. These filters have the following characteristics and application.

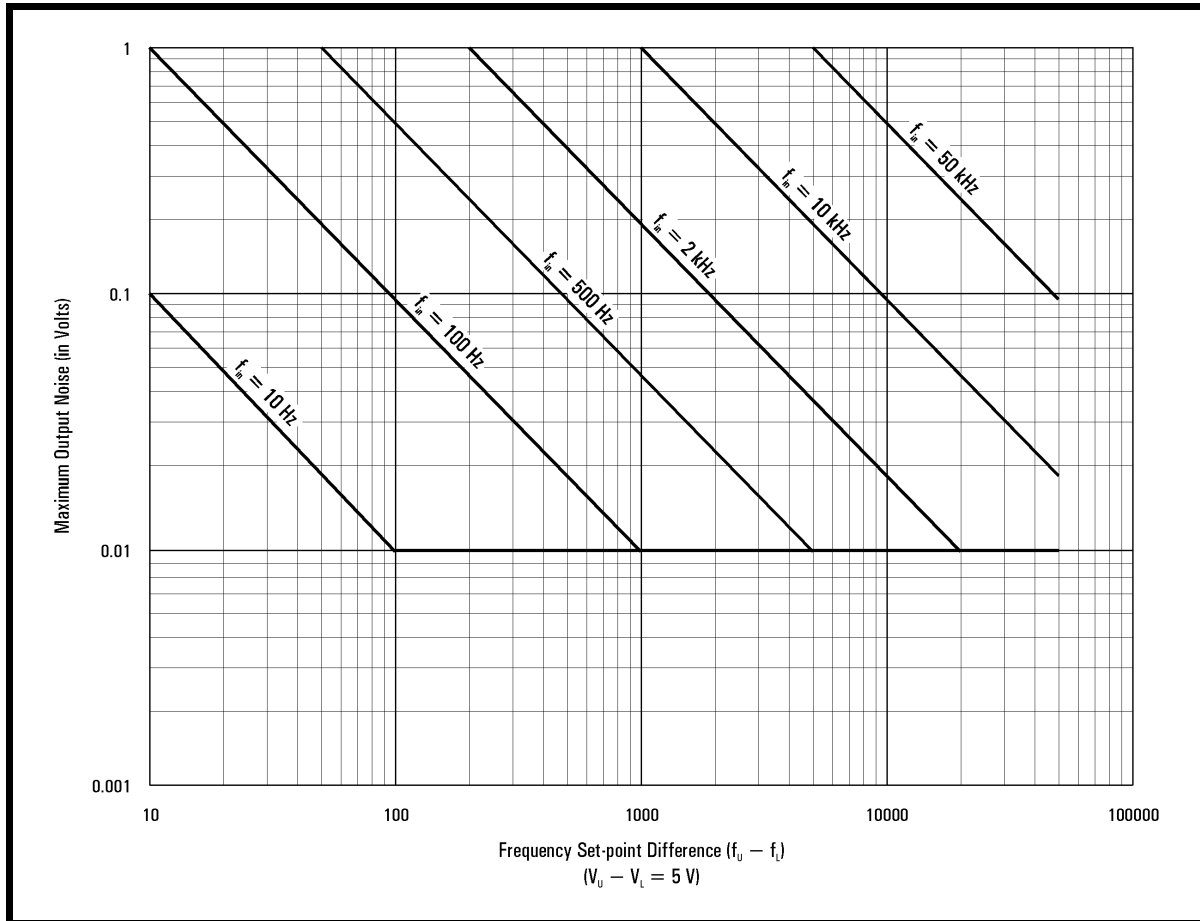

**Figure 4-4**  
**Maximum Output Noise with a 10 mV Sine-wave Input**

#### Input Bandwidth Filter

This filter is used to reduce noise on the input frequency signal to provide reliable triggering. The screens are labeled **MIN**, **MID**, and **MAX** bandwidth corresponding to a single-pole low-pass filter with approximate corner frequencies of 10 Hz (**MIN**), 500 Hz (**MID**), and 150 kHz (**MAX**). The proper setting for this filter depends on the noise frequencies and their relation to the desired signal and is usually set by trial and error. Use the lowest bandwidth setting that provides reliable triggering. During setup, the lowest and highest signal frequencies should be tested for proper operation.

#### Output Filter

This two-pole active filter is used to reduce noise of the output analog signal. Corner frequencies are **1** Hz, **10** Hz, **100** Hz, and **WB** (approximately 1.5 kHz). Since the lower the filter frequency the slower the response, a compromise must be made between noise and response. (Response of the digital filter adds to the response of the analog output filter.) Table 4-2 indicates

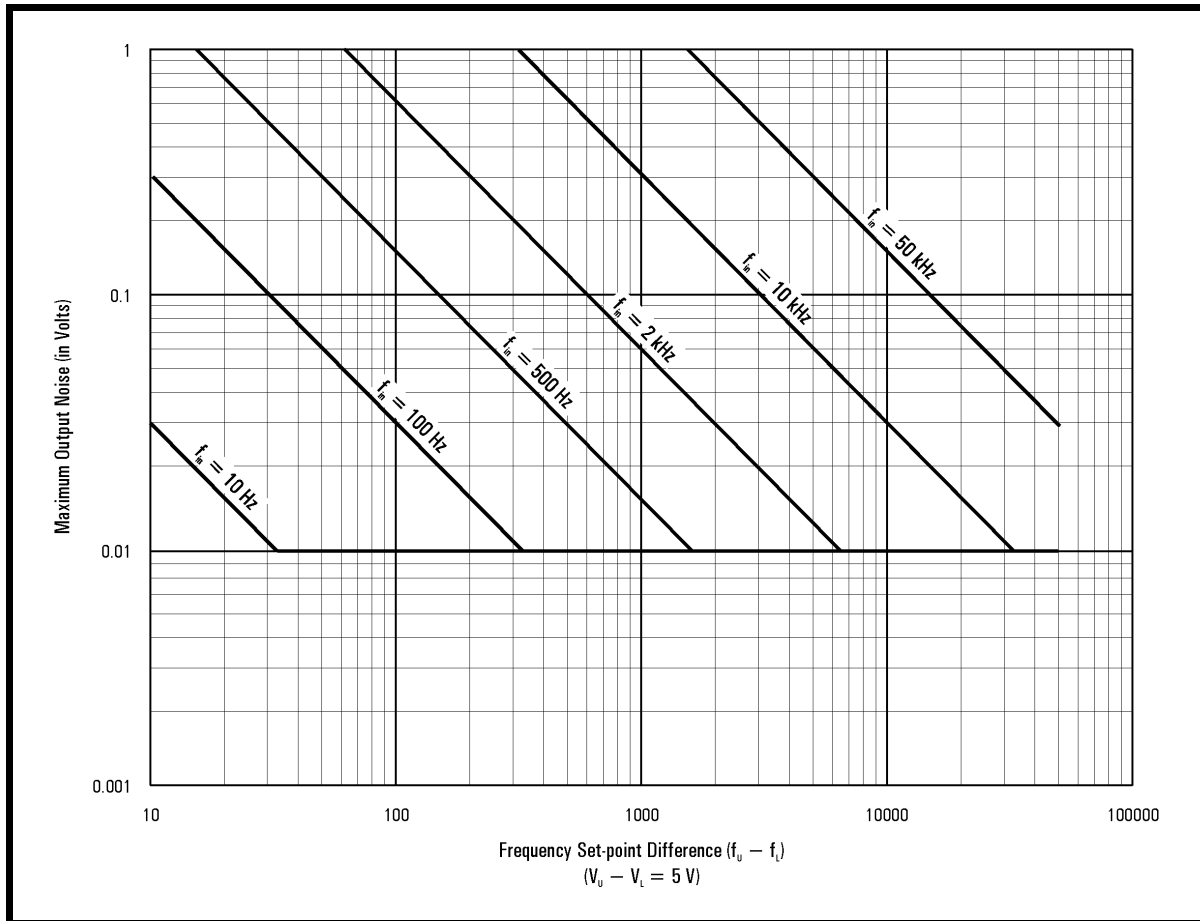

**Figure 4-5**  
**Maximum Output Noise with a 1 V Sine-wave Input**

the response to a step-frequency change for the four filter frequencies assuming the digital filter is set to a **PULSES/REVolution** of **001**. In general, the user should select the lowest filter setting consistent with the response requirements of the application.

**Table 4-2**  
**Response Time Versus Output Filter Setting**

Output Filter in Hz	Approximate Response Time in Seconds
WB (1500)	0.005*
100	0.055*
10	0.5*
1	5.0*

\* add  $1/f_{in}$  where  $f_{in}$  is the input frequency

**Digital Filter**

For operational frequencies up to 1 kHz, this unique filter uses digital averaging of the converted input signal to eliminate the unwanted effects of a signal whose frequency varies in a periodic manner. For example, the output frequency of a paddle-wheel flow sensor usually changes as the wheel rotates because the paddles are not evenly spaced. If the sensor has eight paddles, its output will consist of a repeating sequence of eight pulses. If this signal is fed to a frequency-to-voltage converter without this filtering, the output analog signal will have a cyclic component with a period equal to the period of rotation of the device. However, by using the digital filter with an eight-pulse running average, the period variation is averaged out and a much more stable analog output is obtained.

Figure 4-6 illustrates the function of the digital filter for a signal from an eight-paddle sensor. At first, the unfiltered (stair-step) analog output varies about 5 V; then the speed of rotation is increased so the signal varies about 5.4 V. Keying in eight pulses per revolution changes the analog output to that shown by the smoothed trace. Note that the second cycle of eight steps is changed to a steady 5.0 V level. When the frequency abruptly changes to the 5.4 V level, the digitally-averaged signal linearly changes so that in eight steps, the 5.4 V level is reached. As a result of the digital filter, the variation (noise) caused by the eight-step cycle is eliminated. During and after the transition to a new level, eight-step averaging continues.

The stair-step wave form during the frequency change in Figure 4-6 is a result of the update rate of the unit, which when period averaging is allowed, is longer than 1 ms. That is, period averaging only works below 1 kHz.

The filtering effect of digital averaging is useful in reducing random noise signals as well as periodic signals. Response time will be reduced in direct proportion to the Sample Count setting although response time will change with input frequency. For example, for an eight-count sample period and an input frequency of 64 Hz the response time (to reach final value) will be  $\frac{1}{8}$  s. For a frequency of 6400 Hz the response time will be  $\frac{1}{800}$  s.

The Model 441AL allows the user to set the number of cycles of the period filter from **001** to **999** (**001** being the same as **OFF**) by setting the number as the **PULSES / REVolution**. (See Section III for instructions.)

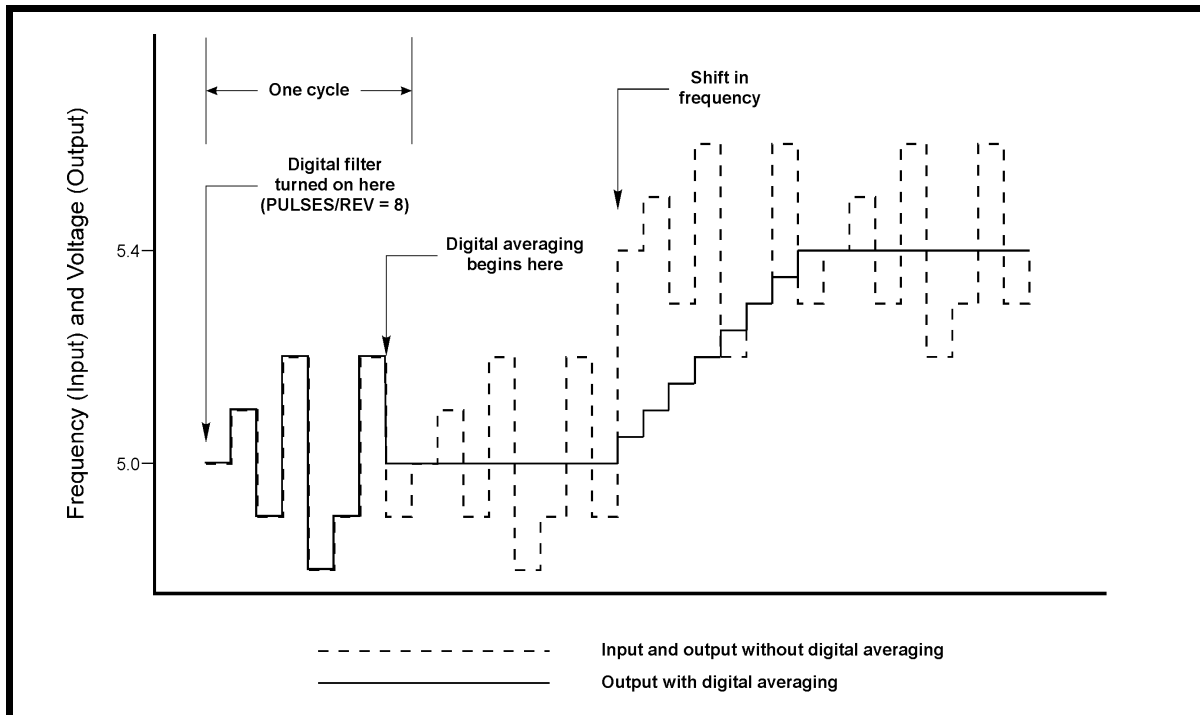

**Figure 4-6**  
**Effects of the Digital (Periodic-error) Filter**

For frequencies exceeding 1 kHz, the periodic filter is automatically turned off. This means that anytime the time interval between two pulses is less than 1 ms, the filter is shut off (even though it has been activated at the front panel by the user) and will automatically turn on (provided it is programmed on by the user) if and when the time interval exceeds 1 ms. Then, as soon as the required number of pulses (determined by the pulses-per-revolution setting) has been received as input, the output will again show the elimination of the periodic error. The user who is operating near 1 kHz should be mindful of this operation.

Applications for the period filter include flowmeters of the turbine or propeller type, rotating-cup anemometers, wheel-speed sensors of the cogged-wheel type (ABS systems) used on automobiles, rotary optical encoders, shaft torque detectors, etc. Usually, periodic errors are caused by irregular spacing of the steps of the rotating element of the device, but they can also be caused by lack of concentricity between the rotating element and the pick-off (runout).



Another application would be a jet turbine engine whose rpm needs to be known or controlled exactly. A cogged wheel rides on the engine shaft that has spacing irregularities. This causes a slight variation in the output pulse spacing and would produce noise in the resulting analog output of the Model 441AL. This noise would prevent knowing the exact rpm. If the wheel has 40 cogs, using a **PULSES / REV**olution setting of **040** would eliminate the noise caused by the spacing irregularities. Therefore, using digital averaging allows the output to be as exact as the inherent high accuracy and stability of the Model 441AL.

## RESPONSE TIME

Response to an abrupt frequency change is  $0.005 \text{ s} + 1/f_{new}$  with the output filter set to wide-band ( $f_{new}$  is the new frequency). Thus, if the input frequency is 10 Hz and suddenly changes to 1000 Hz, the analog output will assume the new value in less than 6 ms. For lower filter frequencies,  $5/f_{co}$  (in seconds) must be added.

## UPDATE RATE

The update rate is 1 ms *or*  $1/f_{in}$ , whichever is greater.

## LATENCY

Latency is the time required for the output to respond to a change in input frequency. Latency in the Model 441AL is within 1 ms of each falling edge of the input signal for input frequencies above 1 kHz, and within  $1 \text{ ms} + 1/f_m$  for frequencies below 1 kHz.

## FRONT-PANEL INDICATION

The display on the front panel indicates the frequency of the incoming signal with a resolution of five digits and the pulses per revolution setting of the periodic-error filter. Displaying the input frequency serves several purposes during setup and operation of a test. First, it gives the operator a “warm and fuzzy” feeling knowing that everything works. It confirms that the pickup device is working and connections to the converter are correct. If the frequency is approximately correct, it shows that the signal level is probably acceptable to the converter. During the test, an operator can monitor the read-out to get a quick look at the frequency data. The green front-panel LED will extinguish if no signal is present, and the display will read 0.0000. If the input signal exceeds 50 kHz the read-out will continue to read correctly until the frequency exceeds 63 kHz. Above this frequency, the read-out will show dashes. (The analog output also will continue to be correct until it reaches approximately 11 V.) The setting of periodic filter has also been selected for this screen because an incorrect setting such as the wrong number of pulses per revolution increases noise as can using it above 1 kHz.

## CALIBRATION

The **CAL**ibration mode allows the operator to set a calibration signal from 0 Hz to 50 kHz in 1 Hz increments. When **CAL** is enabled, the analog output assumes a voltage value of

the **CAL** frequency in accordance with the frequency and voltage set points. The calibration circuit does not test the input-signal-conditioning circuitry and ignores any input signal.

To turn on the calibration signal, go to the **CAL** screen, adjust the frequency, and set **OFF-ON** to **ON**. At this time, the output will assume the analog value corresponding to the frequency and voltage set conditions. This output and the **CAL** screen will remain until it is exited or the **CAL** is toggled **OFF**.

The **CAL** mode can be used as a highly accurate linearity check of the equipment that follows the Model 441AL. First, perform the voltage alignment as described in Section III, and then step the calibration settings over the range of interest, perhaps from zero to full scale in 10% increments. This test should produce a system linearity check within an uncertainty of 0.1% of full scale.

---

## Section V

# Theory of Operation

---

### GENERAL

This discussion is organized to follow the signal flow, and as such describes the hardware signal conditioning first, then the firmware, and then the hardware output stages. The power-supply discussion is placed after the signal-flow discussion. Refer to Figure 5-1, the block diagram of the Model 441AL.

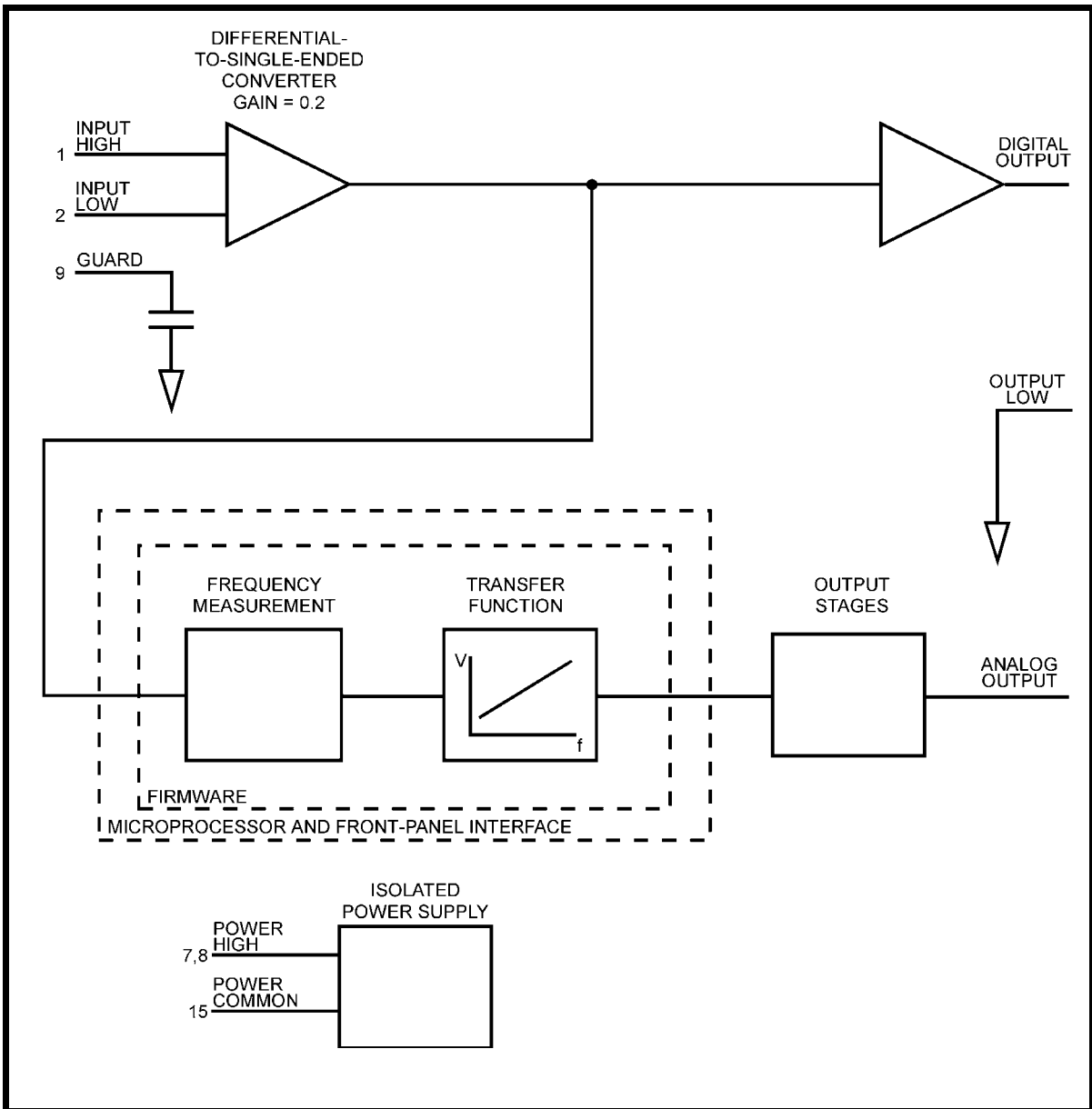

**Figure 5-1**  
**Model 441AL Block Diagram**

**SIGNAL CONDITIONING (HARDWARE)**

The two signal inputs feed a differential amplifier with a gain of 0.2. The signal then feeds to the microcontroller, which detects high-to-low transitions. High-to-low transitions are detected since many signal sources produce faster fall times than rise times. When the input signal contains significant noise, any uncertainty in transition detection results in uncertainty in frequency measurement. Slow transition times can cause transition-detection uncertainties when the signal contains noise.

**FREQUENCY MEASUREMENT (FIRMWARE)**

Frequency measurement is based on the time period between high-to-low transitions of the input signal. If the period of time between high-to-low transitions of the input signal is greater than one millisecond, frequency is determined by taking the reciprocal of each signal period. If the period of time is less than one millisecond, high-to-low transitions are accumulated until one millisecond has elapsed. Frequency is then determined by dividing the number of transitions accumulated by the period of time required to accumulate those transitions. Granularity in period measurement is 667 ns, and the frequency is measured no faster than once per millisecond.

**TRANSFER FUNCTION (FIRMWARE)**

Once the frequency has been determined, output scaling and offset must be applied to determine the proper output voltage.

First, the measured frequency is subtracted from the lower-frequency set-point. Then, that difference is multiplied by the difference between the upper- and lower-voltage set-points, and then that value is divided by the difference between the upper- and lower-frequency set points. A correction factor is added to compensate output-stage component variations, and the resulting value is fed to the output DAC (digital-to-analog converter). This correction factor is determined by the plus- and minus-ten-volt alignment made during setup.

The firmware has the capability of performing the entire process 1000 times per second, so the output voltage will properly represent the frequency of a particular cycle of the input signal approximately one millisecond after a low-to-high transition of the signal (for input signals of one millisecond or greater period).

**OUTPUT STAGES (HARDWARE)**

The output stages consist of a 14-bit DAC, an analog filter, and an output driver. These circuits provide an output voltage range of approximately plus and minus eleven volts. The filter is low-pass, two-pole, with Bessel characteristics; and is factory set to 1 Hz, 10 Hz, and 100 Hz cutoff frequencies. The wideband position available from the front panel substitutes a single-pole low-pass filter set to approximately 1500 Hz. The output driver provides low-impedance outputs and is limited to approximately 20 milliamperes of output current.

**POWER SUPPLIES (HARDWARE)**

The Ectron Model 441AL contains an isolated switching power supply which runs at approximately 20 kHz. All internal circuitry operates from this module, which is transformer coupled to provide excellent isolation from the user's power supply.

---

## Section VI

# Alignment and Calibration

---

This section details the alignment and testing required to verify the proper performance of the Model 441AL. The basic alignment and calibration procedure is presented first, followed by optional additional tests that the user may choose to perform. A blank calibration test report is also included at the end of the section. Before proceeding, the operator should become familiar with the operation of the Model 441AL.

### EQUIPMENT REQUIRED

#### Basic Alignment and Calibration

<b>DMM</b>	Agilent Model 34401A or equivalent. An equivalent must have at least 0.01% accuracy in the range of 0 V dc to 10 V dc.
<b>Oscilloscope</b>	Tektronix Model 7603 (with Model 7A13 vertical and Model 7B53A horizontal plug-in's) or equivalent.
<b>Function generator</b>	Wavetek Model 188 or equivalent.
<b>Frequency meter (if necessary)</b>	Needed if not already present in the DMM being used, and if the function generator does not provide a precise reading of the frequency.
<b>Power supply</b>	Any (10.5 V dc to 32 V dc with at least a 200 mA output).
<b>Mating connector</b>	Fifteen-pin (female) Type D subminiature such as a DA-15S or a DAM-15S.
<b>Switch</b>	One single-pole single-throw toggle switch. The test technician can forego the use of this switch, but it does make the tests easier to perform.

#### Additional Tests (Optional)

<b>Power supply</b>	Any (0 V dc to 100 V dc with at least 15 mA output and with monitoring capabilities).
<b>FET</b>	International Rectifier IRF840 or equivalent. <sup>1</sup>
<b>Switch</b>	One additional single-pole single-throw toggle switch. The test technician can forego the use of this switch, but it does make the tests easier to perform.

---

<sup>1</sup> If a pulse generator or square-wave generator capable of generating waveforms of 0 V to 100 V is available, it can be used instead of the generator, 1 k $\Omega$  resistor, 10 k $\Omega$  resistor, dc supply, S2, and IRF840 FET as is shown in Figure 6-4.

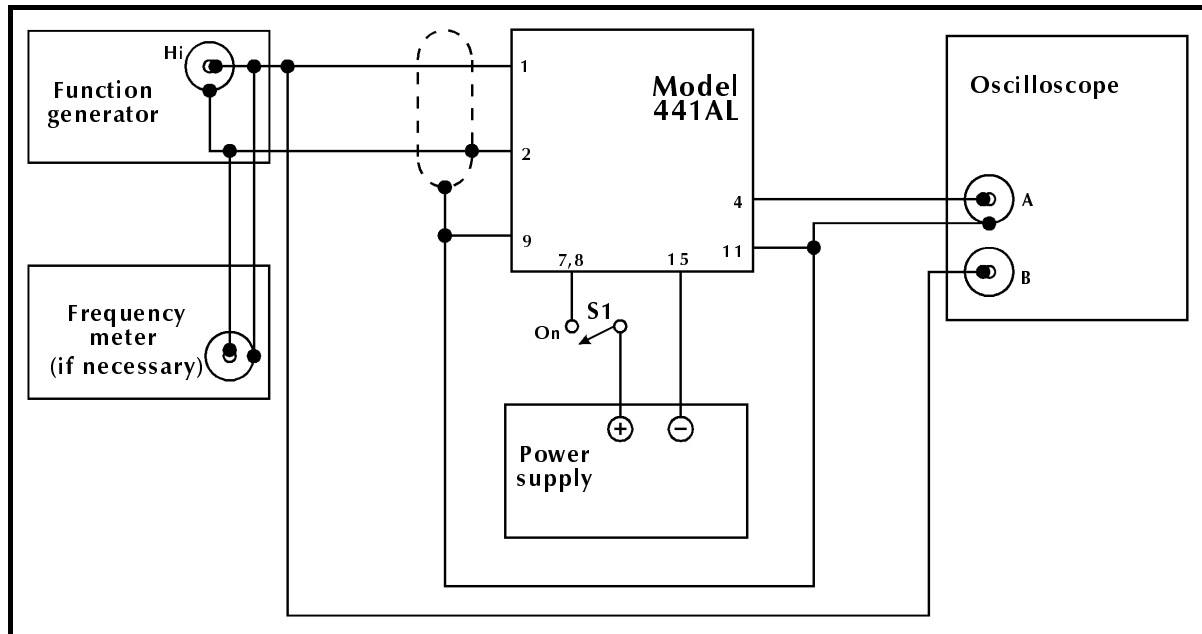

**Figure 6-1**  
**Frequency-range Setup**

## PRE-CALIBRATION

### Setup

Connect the Model 441AL as shown in Figure 6-1. Set the power supply to any voltage from 10.5 V dc to 32 V dc and set S1 to On.

When the Model 441AL is turned on, the **OPERATE** screen will normally appear. If **ALIGN REQ'D** appears instead, adjust either of the front-panel controls to go to the **OPERATE** screen.

### Frequency Range

Press the display once to go to **FREQUENCY**. Set the **Upper** frequency to **50000** and the **Lower** frequency to **00000**.

Press the display again to go to **VOLTS**. Set the **Upper** voltage to **+10.0** and the **Lower** voltage to **+00.0**.

Press the display six times (or wait approximately twenty seconds) to return to **OPERATE**.

Set the function generator for a 50 kHz square wave of 5 V p-p. Verify the waveform is present on the oscilloscope.

Increase the frequency on the function generator until the waveform disappears on the oscilloscope. Record the highest frequency for which the Model 441AL produces an output. If needed, use the frequency meter to determine the exact frequency.

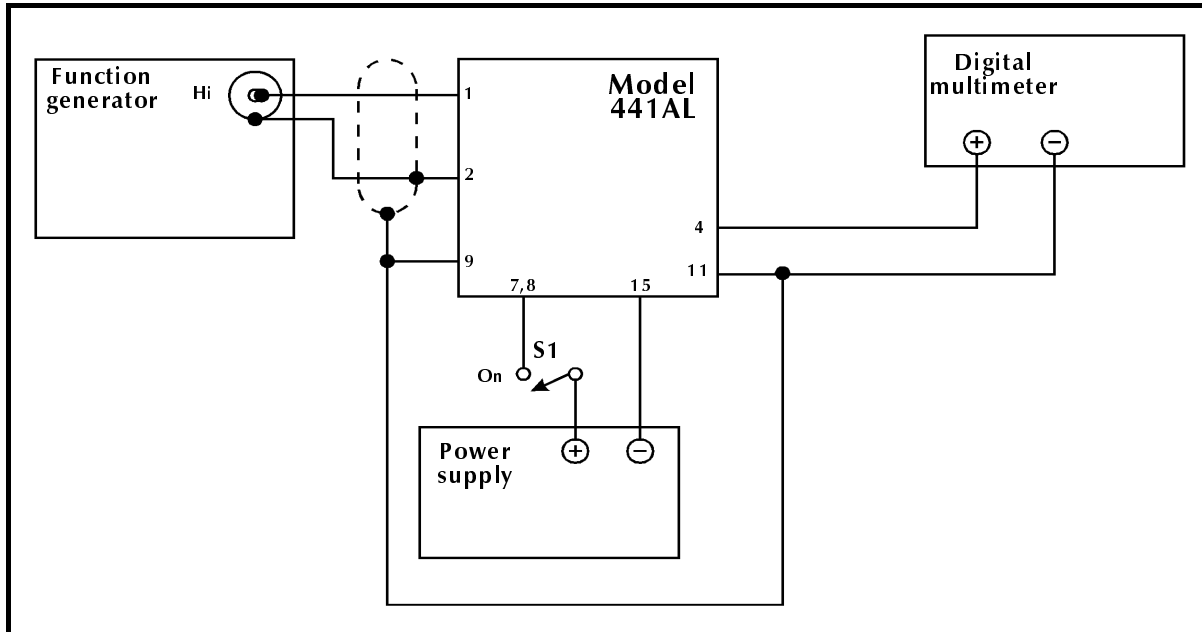

**Figure 6-2**  
**Frequency-calibration Setup**

Press the display once to go to **FREQUENCY**. Set the **Upper frequency** to **00001**.

Press the display seven times (or wait approximately twenty seconds) to return to **OPERATE**.

Set the function generator to 1 Hz. Verify the Model 441AL registers the frequency.

Reduce the frequency on the function generator until the Model 441AL no longer registers the input. (The reading will alternate between --- and **0**.) Record the minimum frequency.

### Frequency Calibration

Connect the Model 441AL as shown in Figure 6-2 and set S1 to On.

Press the display once to go to **FREQUENCY**. Set the **Upper frequency** to **01000** and the **Lower frequency** to **00000**.

Press the display seven times (or wait approximately twenty seconds) to return to **OPERATE**.

Set the function generator to 1 kHz.

When the DMM's reading stabilizes, record the voltage.

Press the display once to go to **FREQUENCY**. Set the **Upper frequency** to **50000**.

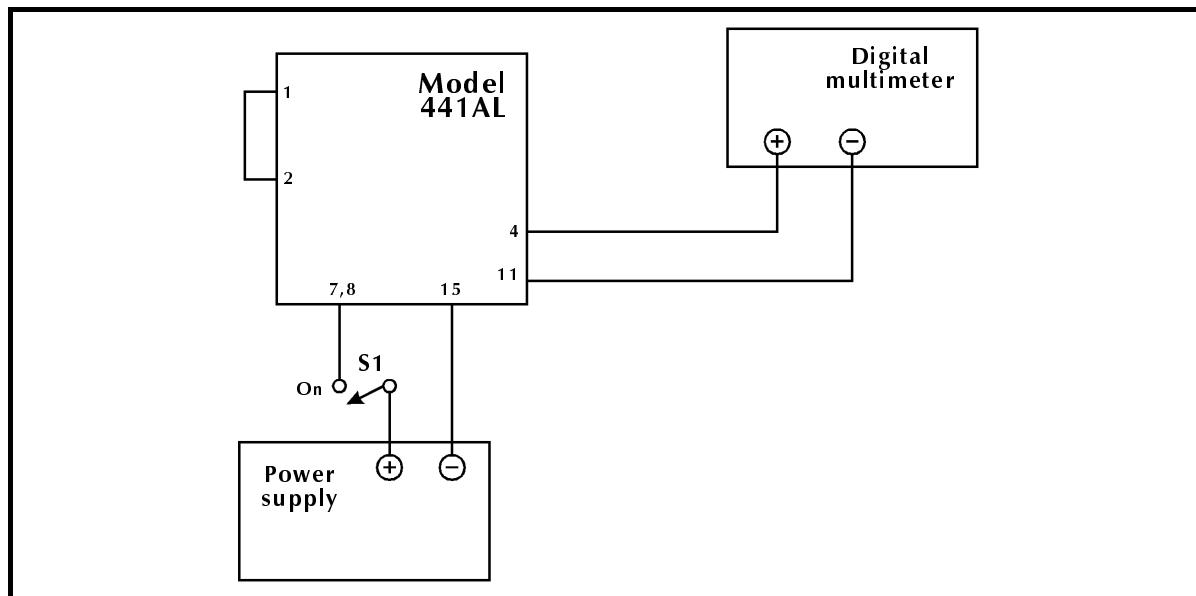

**Figure 6-3**  
**Alignment**

Press the display seven times (or wait approximately twenty seconds) to return to **OPERATE**.

Set the function generator to 50 kHz.

When the DMM's reading stabilizes, record the voltage.

## ALIGNMENT

### Setup

Connect the Model 441AL as shown in Figure 6-3 and set S1 to On.

### Screen Adjustment

From the **OPERATE** screen, press and hold the display/push button for one second to activate the **VIEW ANGLE** screen. Adjust the encoder counterclockwise and clockwise to verify the view angle is adjustable in both directions. Turning it clockwise darkens the screen and counterclockwise lightens it. When finished, set the knob for the best viewing contrast.

### Voltage Alignment

While still at **VIEW ANGLE**, press the display once to go to **ADJUST -10 V**. Adjust the encoder until  $-10.000\text{ V} \pm 0.005\text{ V}$  is obtained on the DMM. The three digits on this display (maximum range of  $\pm 750$  counts) are provided as a reference if needed. The least count is  $\approx 1.3\text{ mV}$ . Record the DMM reading.

Press the display again to go to **ADJUST +10 V**. Rotate the encoder until the DMM reads  $+10.000\text{ V} \pm 0.005\text{ V}$ . The three digits on this display (maximum range of



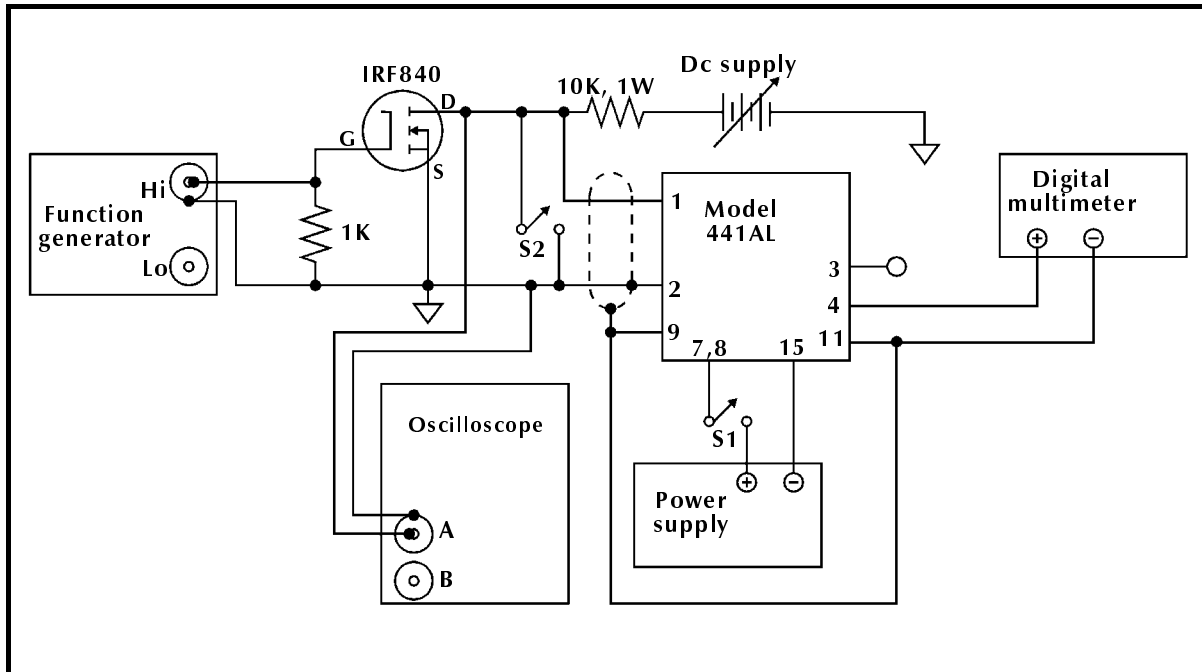

**Figure 6-4**  
**Optional Tests**

$\pm 750$  counts) are provided as a reference if needed. The least count is  $\approx 1.3$  mV. Record the DMM reading.

Press the display again to return to the **OPERATE** screen.

## POST-CALIBRATION

Follow the same procedure as given above for pre-calibration. This completes the alignment and calibration of the Model 441AL.

## OPTIONAL CALIBRATION TESTS

Connect the Model 441AL as shown in Figure 6-4 and set S1 to On.

### Zero in, zero out

From **OPERATE**, press the display once to go to **FREQUENCY**. Set the **Upper** frequency to **50000** and the **Lower** frequency to **00000**.

Press the display again to go to **VOLTS**. Set the **Upper** voltage to **+10.0** and the **Lower** voltage to **+00.0**.

Press the display twice more to go to **INPUT SENS** (The **OUTPUT FILTER** need not be set at this time.) and rotate the encoder to display **MAX**.

Press the display again to go to **INPUT B/W** and again rotate the encoder to display **MAX**.

Press the display twice (or wait approximately twenty seconds) to return to **OPERATE**.

With S2 closed, the output of the Model 441AL, as read on the DMM, should be 0 V  $\pm$ 0.005 V, and the green light should be out.

**Sensitivity**

Set the function generator for a 5 Hz square wave of maximum-amplitude and open S2. Turn on the dc supply and adjust it for a 0 V to 5 V square wave as viewed on the oscilloscope. The frequency displayed should be approximately **5.0000**.

Repeat the previous paragraph with the function-generator frequency set to 50 kHz. The frequency displayed should be approximately **50000**.

Set **INPUT SENS** to the settings listed in Table 6-1 and repeat the above sensitivity tests.

**Digital Output**

Connect an oscilloscope to the digital output (Pin 3) and verify that the output is a 0 V to 5 V square wave at the input frequency.

**Table 6-1**  
**Input Sensitivity**

<b>INPUT SENS</b>	<b>INPUT VOLTAGE</b>
MAX	0 V to 5 V
MID	0 V to 25 V
MIN	0 V to 100 V

**Ectron Model 441AL Calibration Test Report**

Customer \_\_\_\_\_  
Address \_\_\_\_\_  
\_\_\_\_\_  
\_\_\_\_\_

Date \_\_\_\_\_  
Serial Number \_\_\_\_\_  
Report Number \_\_\_\_\_

	<b>Measurement</b>	<b>Specification</b>
<b>PRE-CALIBRATION</b>		
<b>Frequency Range</b>	Max _____ kHz	>50 kHz
	Min _____ Hz	<1 Hz
<b>Frequency Calibration</b>	50 kHz _____ V	10 V ±0.0079 V
	1 kHz _____ V	10 V ±0.0079 V

**ALIGNMENT**

<b>Frequency Range</b>	+10 V _____ V	+10 V ±0.005 V
	-10 V _____ V	-10 V ±0.005 V

**POST-CALIBRATION**

<b>Frequency Range</b>	Max _____ kHz	>50 kHz
	Min _____ Hz	<1 Hz
<b>Frequency Calibration</b>	50 kHz _____ V	10 V ±0.0079 V
	1 kHz _____ V	10 V ±0.0079 V

Temperature: \_\_\_\_\_ °C                      Relative Humidity: \_\_\_\_\_ %

Remarks: \_\_\_\_\_  
\_\_\_\_\_

Technician: \_\_\_\_\_                      Inspection: \_\_\_\_\_

**EQUIPMENT USED**

Manufacturer	Model	Serial Number	Cal Date	Next Cal Due
_____	_____	_____	_____	_____
_____	_____	_____	_____	_____
_____	_____	_____	_____	_____



---

## Section VII

# Parts Lists

---

### NAMES OF MANUFACTURERS

Table 7-1 lists the manufacturers of the components used by Ectron in the products for which parts lists and schematics are provided. They are listed numerically for easy cross reference to the parts lists.

**Table 7-1**  
**List of Manufacturers**

<b>Number</b>	<b>Manufacturer</b>	<b>Number</b>	<b>Manufacturer</b>
00027	Allen-Bradley Co.	00726	Rohm
00044	Amphenol	00763	Samtec
00060	Aries Electronics	00808	Siliconix Inc.
00074	Augat Interconnection	00834	Sprague Electric Co.
00091	Bendix Corp.	00845	Standard Power Inc.
00127	Bussmann Div.	00863	Switchcraft Inc.
00128	C&K Components Inc.	00949	Useco
00166	Circuit Assembly Corp.	00987	Winslow International
00206	Data Display Products	01094	Central Semiconductor
00336	Fairchild	01152	TRW-cinch
00464	ITT Cannon	01164	PEM
00493	Kemet, Union Carbide Corp	01166	Kulka Smith
00503	KOA Speer Electronics	01176	Belden
00532	Littelfuse Inc.	01177	Keystone
00564	Philips	01230	Ectron Corporation
00616	Motorola Semiconductor	01264	IRC (Int'l. Resistive Co.)
00628	National Semiconductor	01302	Elco (Cosel)

## MODEL E408-6 ENCLOSURE (Drawings 408-600 and 408-601)

REFERENCE DESIGNATOR	DESCRIPTION	MFR	MANUFACTURER'S P/N	ECTRON P/N
C1,C2,C3	CAPACITOR, 4.7UF/35V TANTALUM	00834	199D475X9035CA2	1-444700-1
C4	CAPACITOR, 4.7UF/50V CERAMIC	00493	C340C475M5U5CA	1-444709-0
CR1, CR2	DIODE, SIGNAL	01094	1N457	1-190457-0
CR3,CR4,CR6,CR7	DIODE, SIGNAL	00628	1N4148	1-194148-0
CR5	ZENER, 11V 11.5MA 500MW	00616	1N962B	1-190962-0
CR8	DIODE, POWER	00336	1N4002	1-194002-0
DS1	LAMP	00206	91W-EWR24H-CR0	4-121007-0
F1	FUSE, 1.5A NORMAL BLOW	00532	31201.5	2-161500-0
F2	FUSE, 1A SLOW BLOW	00532	313001	2-161000-1
J1-J6	CONNECTOR, 6-PIN	00091	PT02A-10-6S	1-310506-1
J7	CONNECTOR, 3-PIN	00091	PT02A-12-3P	1-310103-0
J8	RECEPTACLE, POWER	00863	EAC-309	3-840043-0
J9-J14	CONNECTOR, 15-PIN D	01152	DA-15-SV	1-310015-6
J15-J20	CONNECTOR, BNC	00044	31-010	1-311102-0
P1-P6	CONNECTOR, 6-PIN	00091	PT06A-10-6P(SR)	1-310506-0
P7	CONNECTOR, 3-PIN	00091	PT06A-12-3S(SR)	1-310103-1
PS1, OPTION X	POWER SUPPLY, 28 V	01302	R50U-24-N	5-120026-0
PS1, OPTION Y	POWER SUPPLY, 12 V	01302	R50U-12-N	5-120025-0
Q1,Q2	FET, MOS 1.2-OHM	00808	VN0300L	1-240030-0
Q3	TRANSISTOR, PNP	00628	2N3702	1-213702-0
R5	JUMPER			
R6,R7	RESISTOR, 1MEG/5% 1/4W	00564	5043EM1M000JB	6-174100-0
R8	RESISTOR, 470 OHM 5% 2W	01264	SPH 470 OHM 5% 2W	6-200470-0
R9	RESISTOR, 15K 1/4W 5%	00564	5043CX15K00J	6-172150-0
R10	RESISTOR, 100/5% 1/4W	00564	5043CX100R0J	6-170100-0
S1	SWITCH, TOGGLE	00128	7203-K-Z-G-E	7-110059-0
S2	SWITCH, PUSHBUTTON	00128	8121-J83-Z-G-E-3-2	7-120012-0
S3	SWITCH, TOGGLE	00128	7103-K-Z-G-E	7-110048-0
U1	IC	00808	7661CJ	1-147661-0
XF1,XF2	FUSEHOLDER	00532	342004	2-170006-0
W1, W2	JUMPER, PLUG	00166	CA-02-SJOB	1-319921-0
FOR TOP COVER	SCREW, 6-32 CAPTIVE PANEL	01164	PS10-632-40	3-905032-1
	FERRULE	01166	1670	3-905010-0
	FOOT	01166	2192	3-840008-0
	HANDLE	00949	B1073-12 BRASS CHR M PLT	3-820019-0
	POWER CORD, USA/CANADA	01176	17250B	3-840026-0

## MODEL R408-14 ENCLOSURE (Drawings 408-605 and 408-606)

REFERENCE DESIGNATOR	DESCRIPTION	MFR	MANUFACTURER'S P/N	ECTRON P/N
C1, C2, C3	CAPACITOR, 4.7UF/35V TANTALUM	00834	199D475X9035CA2	1-444700-1
C4	CAPACITOR, 4.7UF/50V CERAMIC	00493	C340C475M5U5CA	1-444709-0
CR1, CR2	DIODE, SIGNAL	01094	1N457	1-190457-0
CR3, CR4, CR6, CR7	DIODE, SIGNAL	00628	1N4148	1-194148-0
CR5	ZENER, 11V 11.5MA 500MW	00616	1N962B	1-190962-0
CR8	DIODE, POWER	00336	1N4002	1-194002-0
DS1	LAMP 12-40V	00206	91W-EWR24H-CR0	4-121007-0
F1	FUSE, 5A/32V 3AG	00127	BK/AGC-5X	2-165000-0
F2	FUSE, 1A/250V 3AG SLOBLO	00532	313001	2-161000-1
J1-J14	CONNECTOR, 6-PIN	00091	PT02A-10-6S	1-310506-1
J15-J28	CONNECTOR, BNC	00044	31-010	1-311102-0
J29-J42	CONNECTOR, 15-PIN	01152	DA-15-SV	1-310015-6
J43	CONNECTOR, 3-P	00091	PT02A-12-3P	1-310103-0
J44	RECEPTACLE, POWER	00863	EAC-309	3-840043-0
P1-P14	CONNECTOR, 6-PIN	00091	PT06A-10-6P(SR)	1-310506-0
P43	CONNECTOR, 3-PIN	00091	PT06A-12-3S(SR)	1-310103-1
PS1, OPTION Y	POWER SUPPLY	01302	R50U-12-N	5-120025-0
PS1, OPTION X	POWER SUPPLY	01302	R50U-24-N	5-120026-0
Q1, Q2	FET, MOS VN 30V 1.2-OHM	00808	VN0300L	1-240030-0
Q3	TRANSISTOR, PNP	00628	2N3702	1-213702-0
R5	JUMPER			
R6	RESISTOR, 1MEG 1/4W 5%	00564	5043EM1M000JB	6-174100-0
R9	RESISTOR, 15K 1/4W 5%	00564	5043CX15K00J	6-172150-0
R10	RESISTOR, 100 1/4W 5%	00564	5043CX100R0J	6-170100-0
S1	SWITCH, TOGGLE	00128	7303KYZGE	7-110024-0
S2	SWITCH, PUSH-BUTTON	00128	8125SHZBE	7-120002-0
S3	SWITCH, TOGGLE	00128	7103KZGE	7-110048-0
U1	IC, VOLTAGE CONVERTER	00808	7661CJ	1-147661-0
W1, W2	JUMPER	00166	CA-02-SJOB	1-319921-0
XF1, XF2	FUSEHOLDER	00532	342004	2-170006-0
	FERRULE	01166	1670	3-905010-0
	GROMMET, 3/8DIA 7/16MOUNT	01166	91107	3-801412-0
	HANDLE, 3 INCH MOD R418-7	01166	1622 OR 1620	3-820002-0
	POWER CORD, USA AND CANADA	01176	17250B	3-840026-0





ZONE	REV	DESCRIPTION	DATE	APPROVED
-	A	RELEASED	JJ 7/1/93	JJC
-	B	INC ECO NO. 1289	JJ 12/1/99	JJC

ZONE	REV	DESCRIPTION	DATE	APPROVED
-	A	RELEASED	JJ 7/1/93	JJC
-	B	INC ECO NO. 1289	JJ 12/1/99	JJC

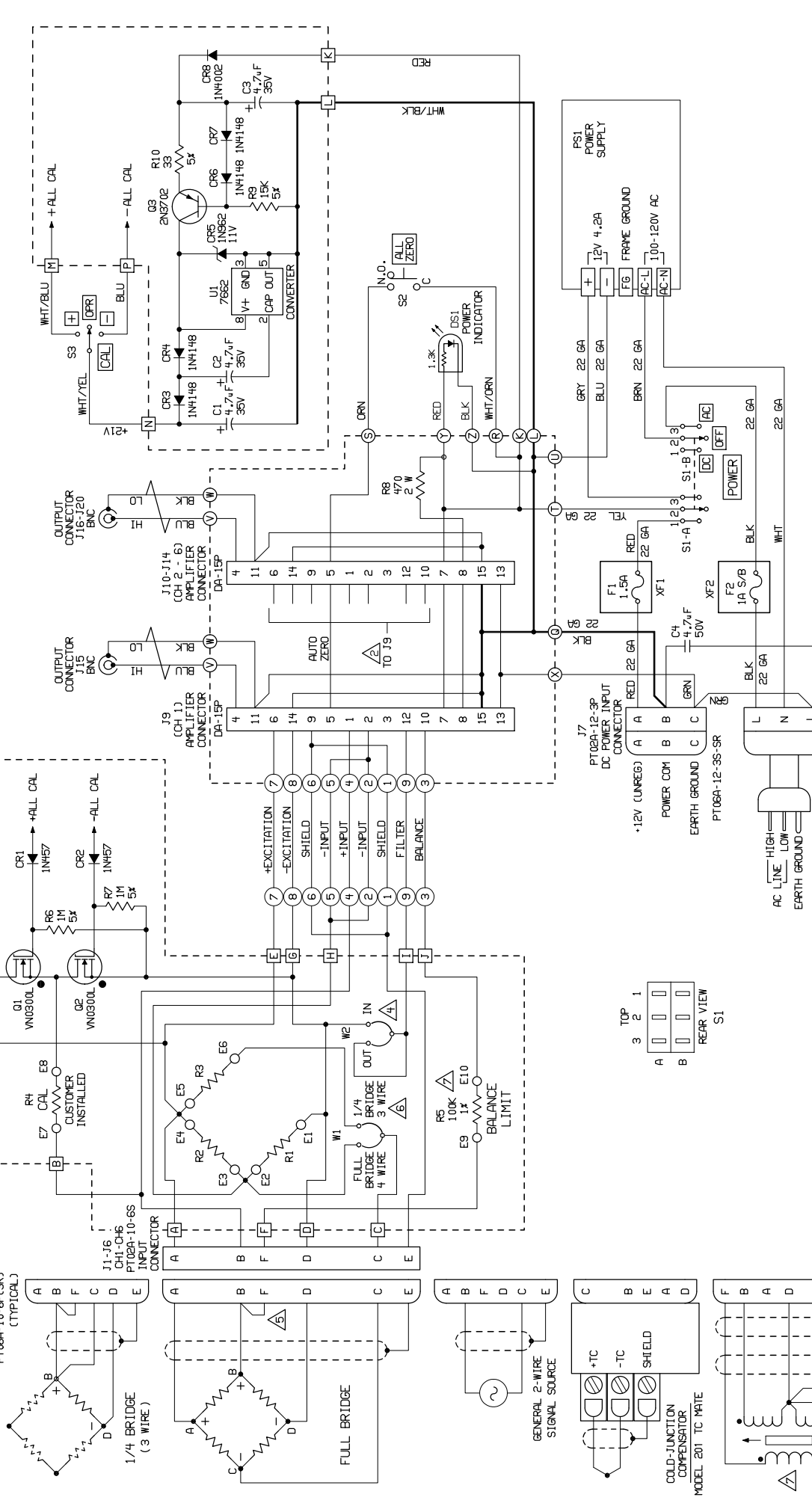

**TYPICAL CUSTOMER CONFIGURATIONS**

PT06A-10-6P(GRO) (TYPICAL)

1/4 BRIDGE (3 WIRE)

FULL BRIDGE

GENERAL 2-WIRE SIGNAL SOURCE

COLD-FUNCTION COMPENSATOR MODEL 201 TC-MATE

LVDI

PT02A-12-3P DC POWER INPUT CONNECTOR

PT06A-12-3S-SR

AC LINE HIGH LOW EARTH GROUND

WHEN USING LVDT CONDITIONER INSTALL JUMPER IN PLACE OF RS.

USE 1/4 POSITION FOR 3-WIRE 1/4 BRIDGE ONLY.

USE FULL POSITION FOR ALL OTHER CONFIGURATIONS.

CUSTOMER INSTALLED JUMPER USED WITH 418 "M" OPTION (GAL) OR MODEL 352Y AMPLIFIERS.

PLUG JUMPER FOR MODEL 352Y 10Hz FILTER.

3. ALL WIRE IS 24 AWG.

**Ectron**  
 4190 ENGINEERS ROAD, SAN DIEGO, CALIF. 92111-1880

TITLE: SCHEMATIC, E408 SERIES  
 DATE: 2/29/95  
 SIZE: F504 NO. 12 VOLT ENCLOSURE  
 DRAWN: J. JACOB  
 CHECKED: *By Clark*  
 APPROVED: \_\_\_\_\_

REV. 408-600 B  
 SCALE: NONE  
 SHEET 1 OF 1



ZONE	REV	DESCRIPTION	DATE	APPROVED
-	A	RELEASED	JJ 7/1/93	Z/C
-	B	INC ECO NO. 1289	JJ 12/1/93	Z/C

REV	DATE	BY	CHK
1	2/29/96	J. JACOB	
2	3/23/96	Chen	

REVISIONS

DATE

BY

CHK

APPROVED

DATE

BY

CHK

APPROVED

DATE

BY

CHK

APPROVED

DATE

BY

CHK

APPROVED

DATE

BY

CHK

APPROVED

DATE

BY

CHK

APPROVED

DATE

BY

TYPICAL CUSTOMER CONFIGURATIONS

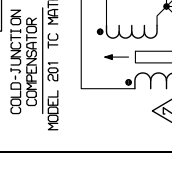
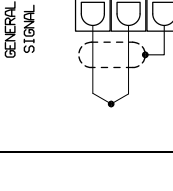
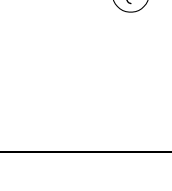
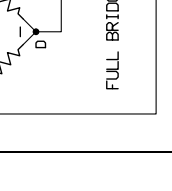
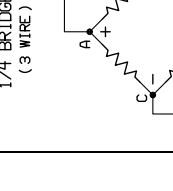
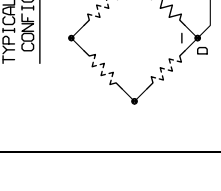
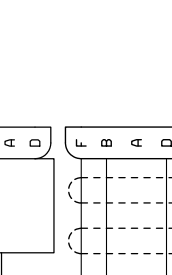
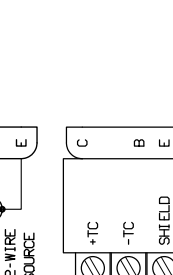
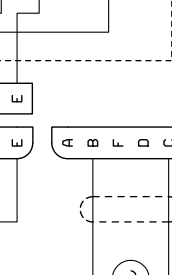
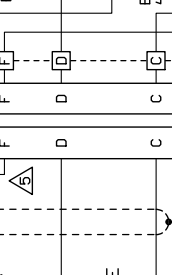
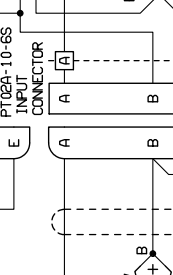
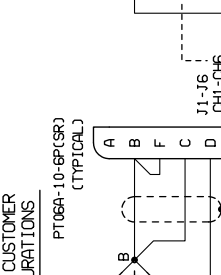
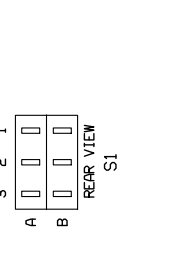
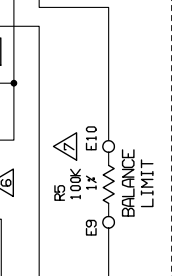
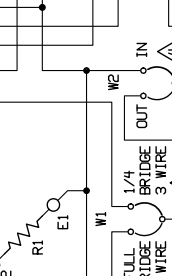
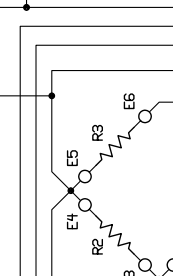
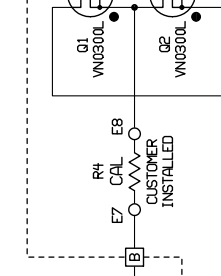
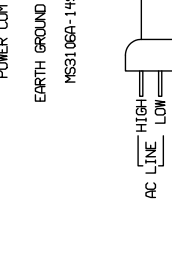
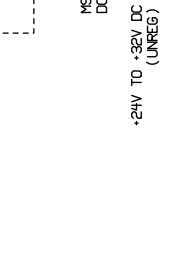
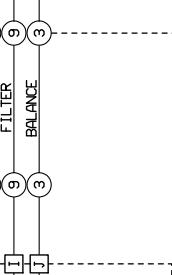
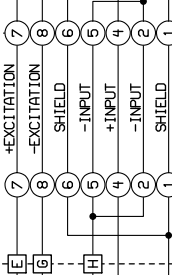
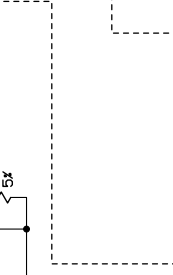
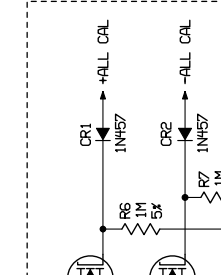
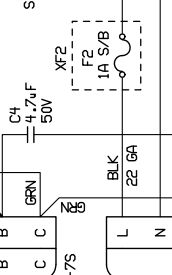
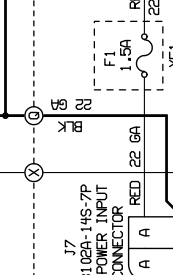
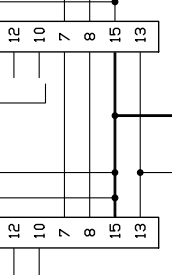
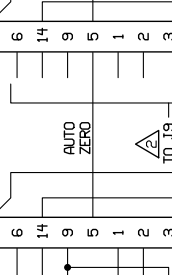
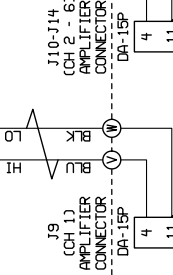
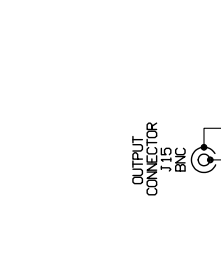
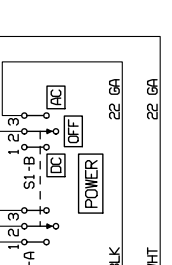
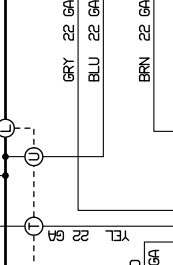
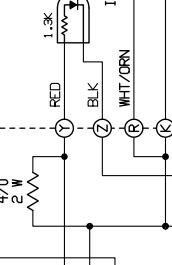
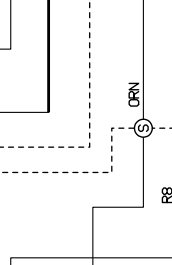
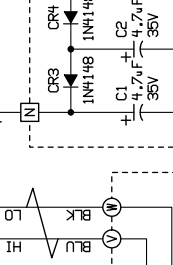
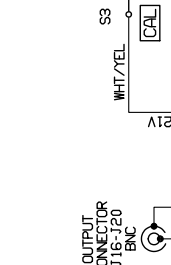

**ectron**  
 8155 ENGINEERS ROAD, SAN DIEGO, CA 92111-3880  
 TITLE SCHEMATIC, E408 SERIES  
 28 VOLT ENCLOSURE  
 SIZE FSC# NO. D 24856  
 DWG NO. 408-601  
 DRAWN J. JACOB  
 DATE 2/29/96  
 APPROVED Chen  
 3/23/96  
 SCALE NONE  
 SHEET 1 OF 1

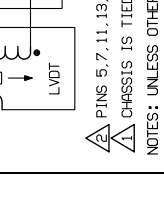
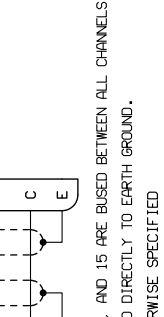
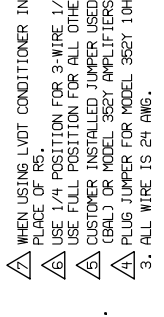
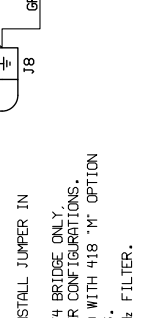
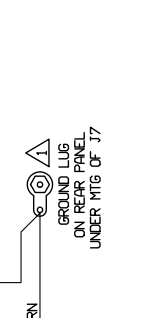
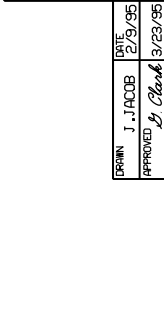

PS1 POWER SUPPLY  
 24V 2.2A  
 FRAME GROUND  
 100-120V AC

MS3106A-14S-7P  
 DC POWER INPUT  
 CONNECTOR  
 +24V TO +32V DC  
 (UNREG)  
 POWER COM  
 EARTH GROUND  
 MS3106A-14S-7S

MS3106A-14S-7S  
 POWER COM  
 EARTH GROUND

MS3106A-14S-7S  
 POWER COM  
 EARTH GROUND

MS3106A-14S-7S  
 POWER COM  
 EARTH GROUND

MS3106A-14S-7S  
 POWER COM  
 EARTH GROUND

MS3106A-14S-7S  
 POWER COM  
 EARTH GROUND

MS3106A-14S-7S  
 POWER COM  
 EARTH GROUND

MS3106A-14S-7S  
 POWER COM  
 EARTH GROUND

MS3106A-14S-7S  
 POWER COM  
 EARTH GROUND

GROUND LUG  
 ON REAR PANEL  
 UNDER MTG OF J7

GROUND LUG  
 ON REAR PANEL  
 UNDER MTG OF J7

GROUND LUG  
 ON REAR PANEL  
 UNDER MTG OF J7

GROUND LUG  
 ON REAR PANEL  
 UNDER MTG OF J7

GROUND LUG  
 ON REAR PANEL  
 UNDER MTG OF J7

GROUND LUG  
 ON REAR PANEL  
 UNDER MTG OF J7

GROUND LUG  
 ON REAR PANEL  
 UNDER MTG OF J7

GROUND LUG  
 ON REAR PANEL  
 UNDER MTG OF J7

GROUND LUG  
 ON REAR PANEL  
 UNDER MTG OF J7

GROUND LUG  
 ON REAR PANEL  
 UNDER MTG OF J7

WHEN USING LVDT CONDITIONER INSTALL JUMPER IN  
 PLACE OF R5.  
 USE 1/4 POSITION FOR 3-WIRE 1/4 BRIDGE ONLY.  
 USE FULL POSITION FOR ALL OTHER CONFIGURATIONS.  
 CUSTOMER INSTALLED JUMPER USED WITH 418 'M' OPTION  
 (BAL) OR MODEL 382Y AMPLIFIERS.  
 PLUG JUMPER FOR MODEL 382Y 10Hz FILTER.  
 3. ALL WIRE IS 24 AWG.

WHEN USING LVDT CONDITIONER INSTALL JUMPER IN  
 PLACE OF R5.  
 USE 1/4 POSITION FOR 3-WIRE 1/4 BRIDGE ONLY.  
 USE FULL POSITION FOR ALL OTHER CONFIGURATIONS.  
 CUSTOMER INSTALLED JUMPER USED WITH 418 'M' OPTION  
 (BAL) OR MODEL 382Y AMPLIFIERS.  
 PLUG JUMPER FOR MODEL 382Y 10Hz FILTER.  
 3. ALL WIRE IS 24 AWG.

WHEN USING LVDT CONDITIONER INSTALL JUMPER IN  
 PLACE OF R5.  
 USE 1/4 POSITION FOR 3-WIRE 1/4 BRIDGE ONLY.  
 USE FULL POSITION FOR ALL OTHER CONFIGURATIONS.  
 CUSTOMER INSTALLED JUMPER USED WITH 418 'M' OPTION  
 (BAL) OR MODEL 382Y AMPLIFIERS.  
 PLUG JUMPER FOR MODEL 382Y 10Hz FILTER.  
 3. ALL WIRE IS 24 AWG.

WHEN USING LVDT CONDITIONER INSTALL JUMPER IN  
 PLACE OF R5.  
 USE 1/4 POSITION FOR 3-WIRE 1/4 BRIDGE ONLY.  
 USE FULL POSITION FOR ALL OTHER CONFIGURATIONS.  
 CUSTOMER INSTALLED JUMPER USED WITH 418 'M' OPTION  
 (BAL) OR MODEL 382Y AMPLIFIERS.  
 PLUG JUMPER FOR MODEL 382Y 10Hz FILTER.  
 3. ALL WIRE IS 24 AWG.

WHEN USING LVDT CONDITIONER INSTALL JUMPER IN  
 PLACE OF R5.  
 USE 1/4 POSITION FOR 3-WIRE 1/4 BRIDGE ONLY.  
 USE FULL POSITION FOR ALL OTHER CONFIGURATIONS.  
 CUSTOMER INSTALLED JUMPER USED WITH 418 'M' OPTION  
 (BAL) OR MODEL 382Y AMPLIFIERS.  
 PLUG JUMPER FOR MODEL 382Y 10Hz FILTER.  
 3. ALL WIRE IS 24 AWG.

WHEN USING LVDT CONDITIONER INSTALL JUMPER IN  
 PLACE OF R5.  
 USE 1/4 POSITION FOR 3-WIRE 1/4 BRIDGE ONLY.  
 USE FULL POSITION FOR ALL OTHER CONFIGURATIONS.  
 CUSTOMER INSTALLED JUMPER USED WITH 418 'M' OPTION  
 (BAL) OR MODEL 382Y AMPLIFIERS.  
 PLUG JUMPER FOR MODEL 382Y 10Hz FILTER.  
 3. ALL WIRE IS 24 AWG.

WHEN USING LVDT CONDITIONER INSTALL JUMPER IN  
 PLACE OF R5.  
 USE 1/4 POSITION FOR 3-WIRE 1/4 BRIDGE ONLY.  
 USE FULL POSITION FOR ALL OTHER CONFIGURATIONS.  
 CUSTOMER INSTALLED JUMPER USED WITH 418 'M' OPTION  
 (BAL) OR MODEL 382Y AMPLIFIERS.  
 PLUG JUMPER FOR MODEL 382Y 10Hz FILTER.  
 3. ALL WIRE IS 24 AWG.

WHEN USING LVDT CONDITIONER INSTALL JUMPER IN  
 PLACE OF R5.  
 USE 1/4 POSITION FOR 3-WIRE 1/4 BRIDGE ONLY.  
 USE FULL POSITION FOR ALL OTHER CONFIGURATIONS.  
 CUSTOMER INSTALLED JUMPER USED WITH 418 'M' OPTION  
 (BAL) OR MODEL 382Y AMPLIFIERS.  
 PLUG JUMPER FOR MODEL 382Y 10Hz FILTER.  
 3. ALL WIRE IS 24 AWG.

WHEN USING LVDT CONDITIONER INSTALL JUMPER IN  
 PLACE OF R5.  
 USE 1/4 POSITION FOR 3-WIRE 1/4 BRIDGE ONLY.  
 USE FULL POSITION FOR ALL OTHER CONFIGURATIONS.  
 CUSTOMER INSTALLED JUMPER USED WITH 418 'M' OPTION  
 (BAL) OR MODEL 382Y AMPLIFIERS.  
 PLUG JUMPER FOR MODEL 382Y 10Hz FILTER.  
 3. ALL WIRE IS 24 AWG.

WHEN USING LVDT CONDITIONER INSTALL JUMPER IN  
 PLACE OF R5.  
 USE 1/4 POSITION FOR 3-WIRE 1/4 BRIDGE ONLY.  
 USE FULL POSITION FOR ALL OTHER CONFIGURATIONS.  
 CUSTOMER INSTALLED JUMPER USED WITH 418 'M' OPTION  
 (BAL) OR MODEL 382Y AMPLIFIERS.  
 PLUG JUMPER FOR MODEL 382Y 10Hz FILTER.  
 3. ALL WIRE IS 24 AWG.













REVISIONS

ZONE	LTR	DESCRIPTION	DATE	APPROVED
-	A	INITIAL RELEASE	JJ 2/22/96	BC

6-32 THREAD  
.28 LONG

S/N LABEL

PIN	FUNCTION
1	INPUT HIGH
2	INPUT LOW
3	DIGITAL OUT
4	OUTPUT HI
5	NOT USED
6	NOT USED
7	POWER HI
8	POWER HI
9	GUARD
10	NOT USED
11	OUTPUT LO
12	NOT USED
13	CASE GND
14	NOT USED
15	POWER LO

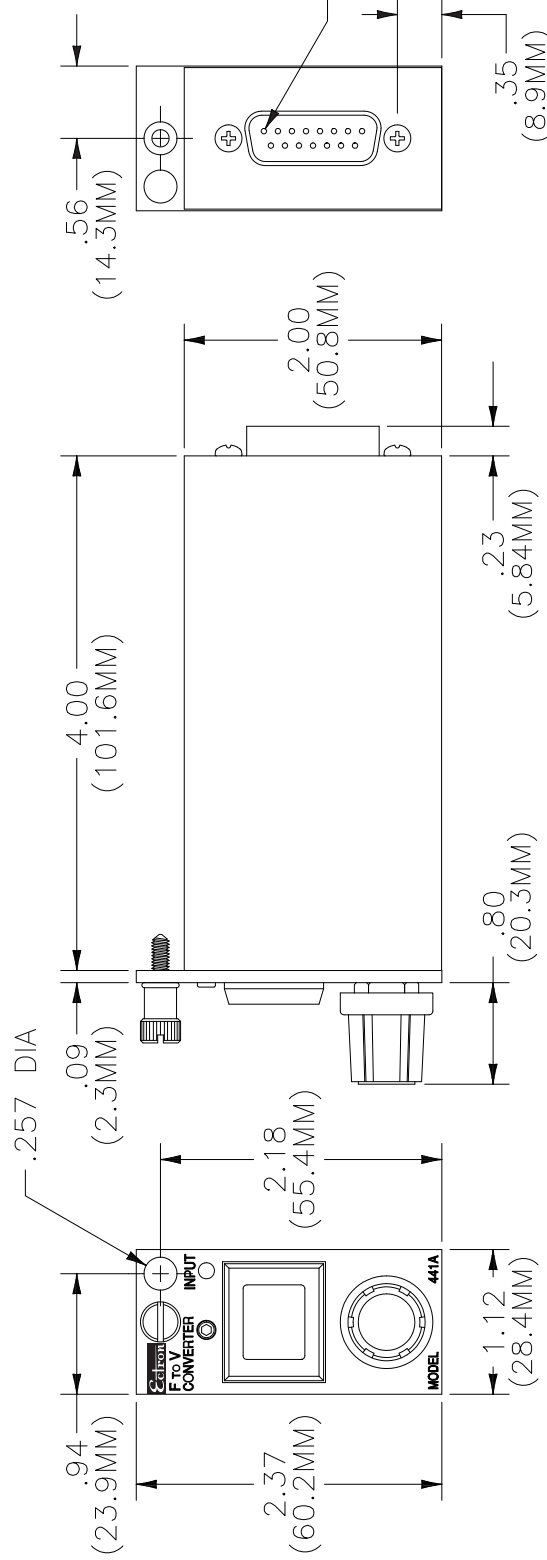
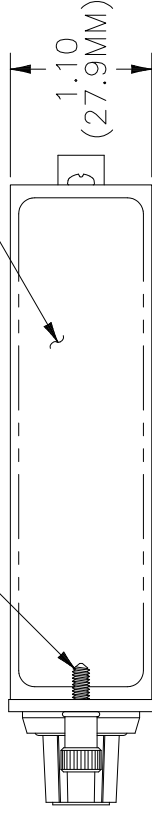

UNLESS OTHERWISE SPECIFIED:  
 • ALL DIMENSIONS ARE IN INCHES  
 • DO NOT SCALE DRAWING  
 • REMOVE BURRS  
 • BREAK SHARP EDGES .005 TO .010  
 • 63° V ALL MACHINED SURFACES  
 • TOLERANCES:

HOLE DIAMETERS	DIMENSIONS
.0135 THRU .125 +.004/-001	FRACTIONS ±1/16
.126 THRU .250 +.005/-001	DEC .X ±.030
.251 THRU .500 +.006/-001	DEC .XX ±.020
.501 THRU .750 +.008/-001	DEC .XXX ±.010
.751 THRU 1.000 +.010/-001	ANGULAR ±.2°
1.001 THRU 2.000 +.012/-001	

MATERIAL

FINISH

DRAWN J. JACOB

DATE 2/22/96

CHECKED *B. Clark*

DATE 2/22/96

APPROVED

**Ectron**  
CORPORATION®  
8159 ENGINEER ROAD, SAN DIEGO, CA. 92111-1980

TITLE  
DIMENSIONAL OUTLINE,  
441A F-V CONVERTER

SIZE FSCM NO. DWG NO. REV  
B 24856 441-901 A

1. MATING CONNECTOR: SOCKET TYPE, 15-PIN,  
D-SUBMINIATURE CONNECTOR.

NOTES: UNLESS OTHERWISE SPECIFIED

SCALE 1/1

SHEET 1 OF 1



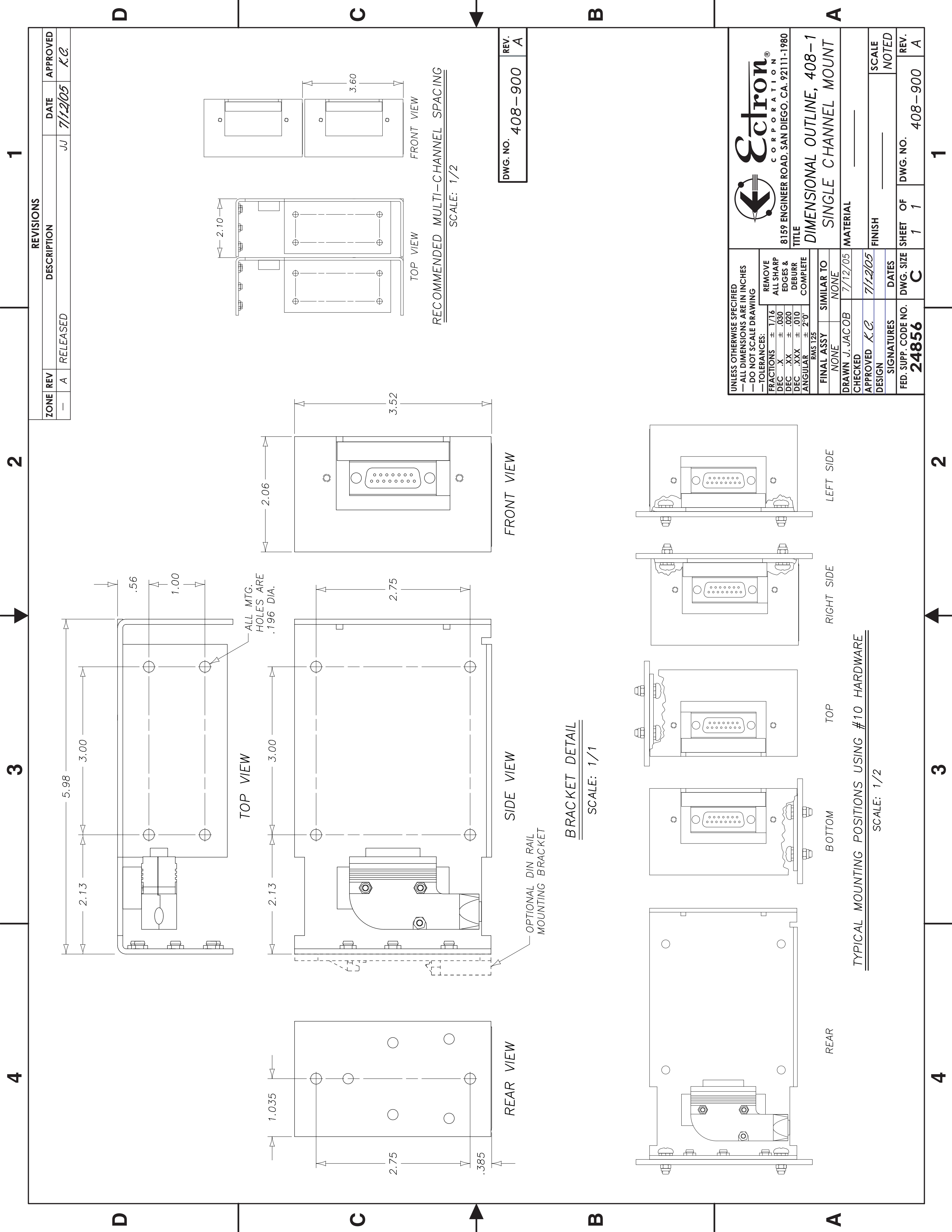

ZONE	REV	DESCRIPTION	DATE	APPROVED
—	A	RELEASED	JJ 7/12/05	K.C.

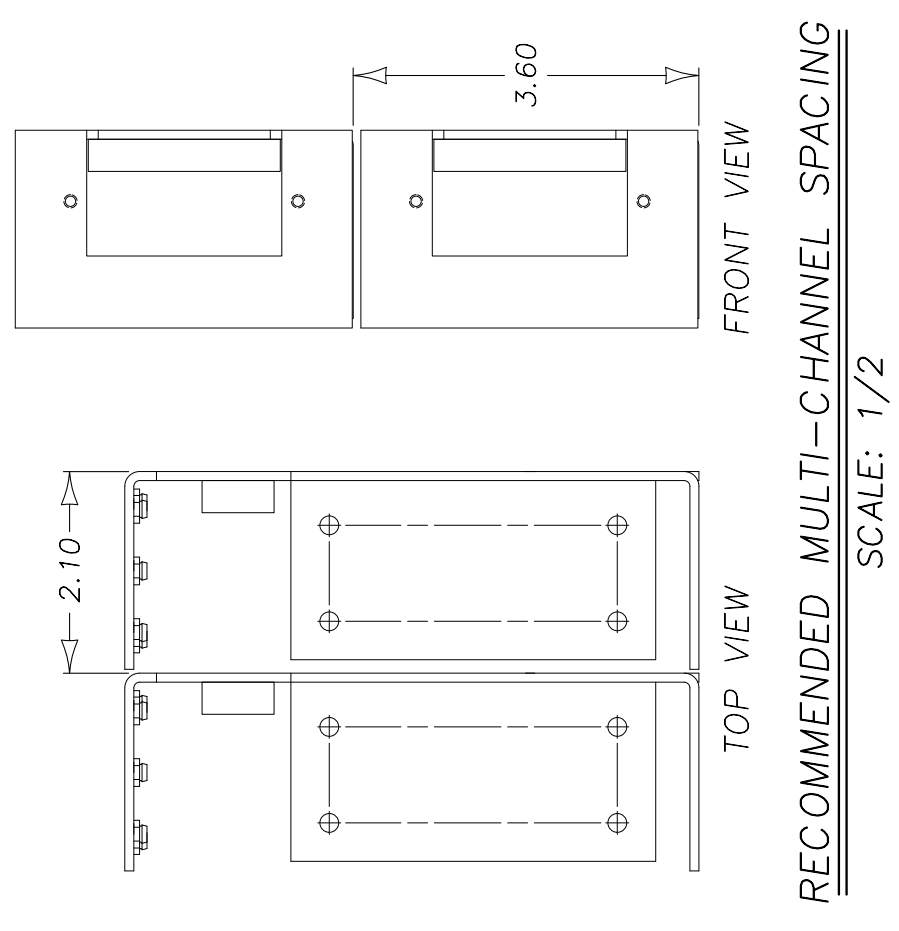

DWG. NO. 408-900  
REV. A

UNLESS OTHERWISE SPECIFIED  
— ALL DIMENSIONS ARE IN INCHES  
— DO NOT SCALE DRAWING

FRAC TIONS ± 1/16  
DEC .X ± .030  
DEC .XX ± .020  
DEC .XXX ± .010  
ANGULAR ± 2°

REMOVE ALL SHARP EDGES & DEBURR COMPLETE

RMS 125

FINAL ASSY	SIMILAR TO
NONE	NONE
DRAWN J. JACOB	7/12/05
CHECKED	
APPROVED K.C.	7/12/05
DESIGN	
SIGNATURES	DATES

FED. SUPP. CODE NO. 24856  
DWG. SIZE C  
SHEET OF 1 1  
DWG. NO. 408-900  
REV. A

**Ectron**  
CORPORATION  
8159 ENGINEER ROAD, SAN DIEGO, CA. 92111-1980

TITLE  
**DIMENSIONAL OUTLINE, 408-1 SINGLE CHANNEL MOUNT**

MATERIAL \_\_\_\_\_  
FINISH \_\_\_\_\_  
SCALE NOTED

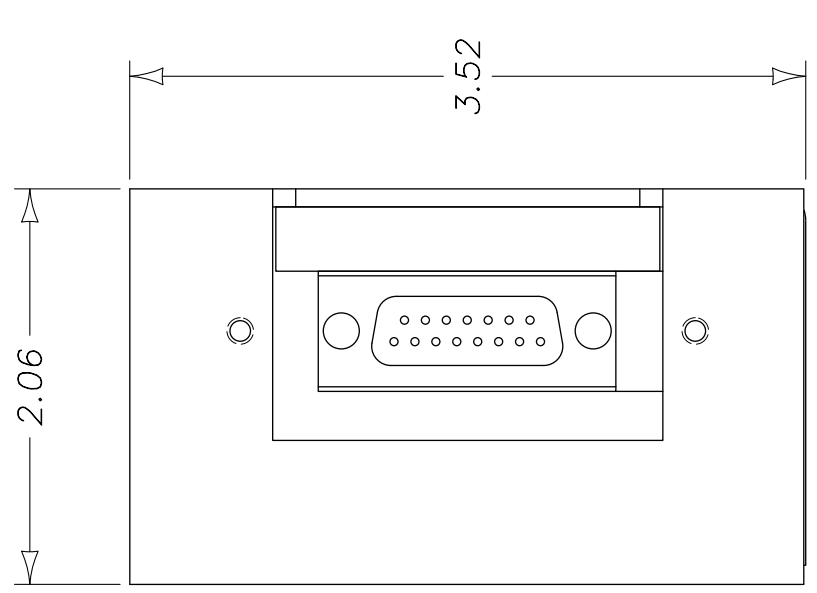
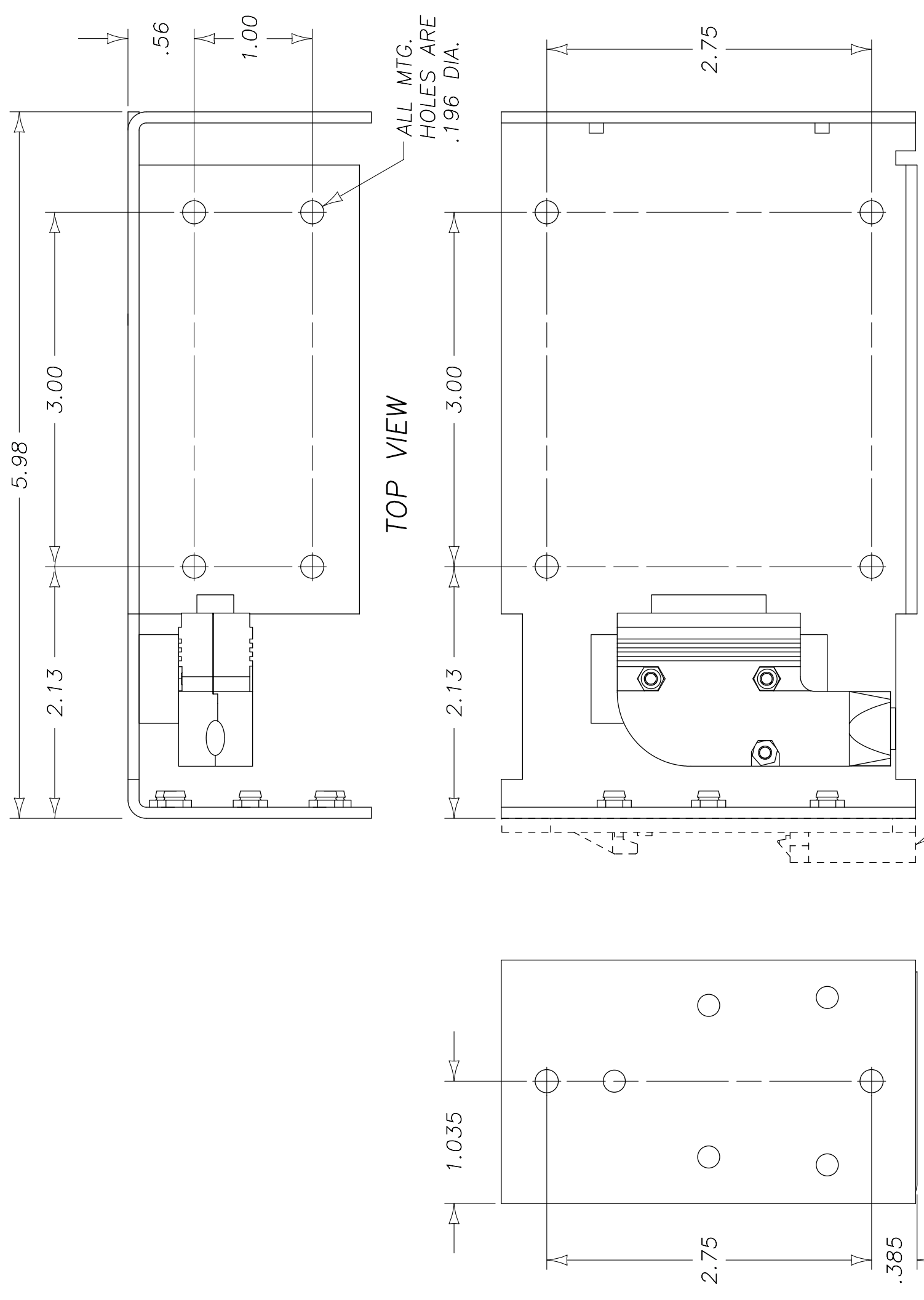

FRONT VIEW

BRACKET DETAIL  
SCALE: 1/1

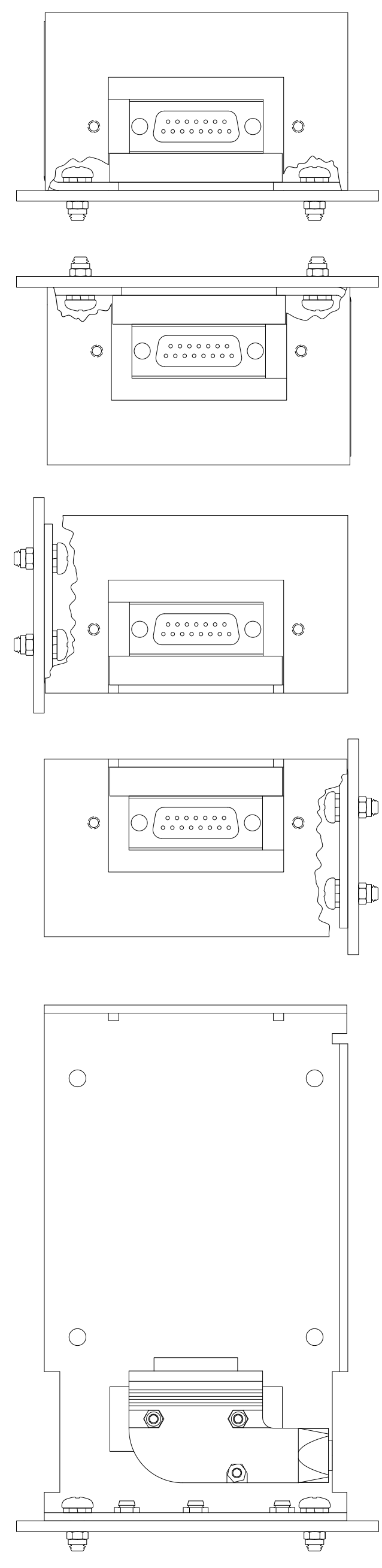

TYPICAL MOUNTING POSITIONS USING #10 HARDWARE  
SCALE: 1/2

REAR VIEW

SIDE VIEW

TOP VIEW

REAR

BOTTOM

TOP

RIGHT SIDE

LEFT SIDE

4

3

2

1

D

C

B

A

D

C

B

A

